

2WIN

OPERATOR MANUAL



Revision notes

Software configuration version	2WIN/2WIN-S 5.6.2
Publication date	2024/06/12
Hardware configuration	Version 40.1
Code	STESK00020
Rev Num.	10.5_EN

General notes

Family: 2WIN VISION ANALYZER

Family intended use: Portable instruments for the measurement of binocular and monocular refraction based on infrared photorefraction

Models: 2WIN, 2WIN-S, 2WIN-S PLUS

Summary







REVISION NOTES.....	2
GENERAL NOTES.....	2
1 MANUFACTURER IDENTIFICATION	5
2 LEGEND OF SYMBOLS	5
3 INTENDED USE OF THE DEVICE.....	6
4 CLASSIFICATION AND APPLIED STANDARDS	6
5 PRECAUTIONS.....	7
6 QUICK USER GUIDE	9
6.1 IMPORTANT	9
6.2 MAIN APPLICATIONS	9
6.3 EXAM CONDITIONS.....	10
6.4 MEASUREMENT TIPS.....	10
7 DESCRIPTION OF THE DEVICE.....	11
7.1 2WIN	11
7.2 LABELS.....	12
7.3 PACKAGE LABELING	13
7.4 INTERFACES	14
7.5 GRAPHICAL USER INTERFACE	16
8 OPERATIVE INFORMATION	17
8.1 OPERATING CONDITIONS	17
8.2 UNPACKING.....	17
8.3 INSERT BATTERY.....	17
8.4 EXTRACT BATTERY	18
8.5 BATTERY-CHARGING	18
8.6 BEFORE OPERATION	19
8.7 DATA MANAGEMENT DISCLAIMER	19
8.8 SOFTWARE LANGUAGE	20
9 OPERATIVE INSTRUCTIONS.....	20
9.1 ENVIRONMENT SETUP.....	21
9.2 DEVICE SETUP	22
9.3 PREPARATION OF THE PATIENT	23
9.4 MEASUREMENT.....	24
9.5 BROWSING MODE	27
9.6 ZOOM FUNCTION.....	27
9.7 MENU	30
9.8 SPHERICAL EQUIVALENT	33
9.9 QUICK MENU.....	33
9.10 CONTEXTUAL HELP.....	33
9.11 SAVE EXAM.....	34
9.12 PRINT TO PORTABLE PRINTER.....	36
9.13 MAIL PRINTING	38
9.14 GAZE.....	38
9.15 CUSTOMIZATION	39

9.16	NOTIFICATION CENTER.....	40
9.17	AGE SELECTION	40
9.18	SCREENING TABLE.....	41
10	WIRELESS CONNECTIONS.....	42
10.1	BLUETOOTH CONNECTIVITY.....	42
10.2	WI-FI CONNECTIVITY	42
10.3	PAIRING AND TRANSFERRING A 2WIN EXAM TO VISIONFIT SC	43
11	REMOTE CONTROL: 2WIN APP-CONNECTION WI-FI	49
12	APPLICATIONS	49
13	SOFTWARE UPDATE INSTRUCTIONS.....	49
13.1	MANUAL UPDATE PROCEDURE.....	49
13.2	AUTOMATIC UPDATE PROCEDURE.....	49
14	MAINTENANCE AND CLEANING INSTRUCTIONS	50
14.1	HOW TO CLEAN THE SYSTEM	51
14.2	STORAGE INSTRUCTIONS.....	51
14.3	INSTRUCTIONS FOR THE CORRECT DISPOSAL OF THE DEVICE.....	51
14.4	INSTRUCTIONS FOR THE CORRECT DISPOSAL OF 2WIN'S PACKAGING	51
14.5	SEPARATE COLLECTION FOR ELECTRICAL AND ELECTRONIC EQUIPMENT	51
15	TROUBLESHOOTING	52
16	ADDITIONAL INFORMATION	53
16.1	TECHNICAL SPECIFICATIONS.....	53
16.2	2WIN RECHARGEABLE BATTERY SPECIFICATIONS.....	53
16.3	C-HE18 BATTERY CHARGER INFORMATION	53
16.4	WI-FI MODULES / BLUETOOTH ADAPTERS	54
16.5	OTHER SPECIFICATIONS	54
16.6	DEVICE WARRANTY	54
16.7	2WIN EMC TABLES.....	55
16.8	C-HE18 BATTERY CHARGER EMC TABLES.....	56
	INFORMATION FOR ASSISTANCE	57
	NOTE FOR SERVICE PERSONNEL ONLY	57
	REMOTE CONTROL	57
	TELEMETRY.....	57
	APPENDIX A – DATA MANAGEMENT DISCLAIMER	58

1 Manufacturer identification

Manufacturer	Adaptica S.r.l.	
Address	Via San Marco, 9/H 35129 Padova (PD) Italy	
Telephone	+39 049 773 968	
Mail	contact@adaptica.com	
Web	www.adaptica.com	

2 Legend of symbols

	Manufacturer identification data
	Date of manufacturing
	Electrical / electronic device subject to the WEEE Directive on waste disposal
	CE mark: this device complies the base requirements of the Medical Device Directive 93/42/CEE
	Warning: necessary information for safety
	Important information
	Read user manual before use

3 Intended use of the device

Instrument for the measurement of binocular and monocular refraction based on infrared (IR) photorefraction.

4 Classification and Applied Standards

Classification according to MDD 93/42/EEC, Annex IX, rule 10

Class IIa.

IP classification

IPX0 (degree of protection provided by the external plastic shells with reference to the penetration of any special material or water).

Classification of C-HE18 battery charger

Class II ME externally powered - IP20 - for continuous operation.

Electromagnetic compatibility

This device has been classified as class B according to the standard IEC 60601-1-2.

Applied standards

EN 60601-1; EN 60601-1-2; EN ISO 15004.

5 Precautions

Electromagnetic compatibility



This device has been tested and found to comply to the limits for medical devices contained in IEC60601-1-2 and in Medical Device Directive 93/42/EEC. These limits are intended to provide reasonable protection against harmful interference in a typical medical installation. This instrument generates, uses and can radiate radio frequency energies and, if not installed and used in accordance with these instructions, may cause harmful interference to other devices in the vicinity. However, there is no guarantee that interference will not occur in a particular installation. If the system does cause harmful interference to other devices, which can be determined by turning the system off and on, try to eliminate the interference by adopting one or more of the following measures:

- reorient and/or relocate the receiving device
- increase the distance between the devices
- In case of charging of the device, connect the system to an outlet on a different circuit than that to which the other devices are connected
- consult the manufacturer or field service technician for help



This equipment has been verified to comply with the limits for a class B computing device, pursuant to FCC Rules. In order to maintain compliance with FCC regulations, shielded cables must be used with this equipment. Operation with non-approved equipment or unshielded cables is likely to result in interference to radio and TV reception. The user is cautioned that changes and modifications made to the equipment without the approval of manufacturer could void the user's authority to operate this equipment.



Portable and mobile RF communications equipment, such as cell phones, can affect medical electrical equipment: any RF communications equipment shall be used no closer than 30 cm (12 inches) to any part of the 2WIN, including its cables.



The area where the device is to be installed has to comply to the IEC/ISO standards related to the medical use of an area.



The device must NOT be used in oxygen rich environments or in presence of flammable products.



The device must not be installed in a room exposed to chemical-physical aggressive agents (such as sulphides, salt, dust, etc.), nor exposed to direct sunlight or lack of ventilation, high humidity, sudden surges or drops in temperature. The safety and efficiency of the instrument are not guaranteed under these conditions.



This device is designed to be used indoor. Do not expose the device to water: this could lead to fire or electric shock.



This device is not to be used during a flight.

Light radiation



The light emitted from this instrument is potentially hazardous. The longer the duration of exposure, the greater the risk of ocular damage. Exposure to light from this instrument when operated at maximum intensity will exceed the safety guideline after 30 minutes.



Do not stare at the light sources of the device from a distance lower than 1 m.

Precautions and general warnings



The clinical interpretation of the data provided by the device is restricted to licensed eye-care practitioners.

The process of making a diagnosis using the device results is the responsibility of the eye-care practitioner. A device-specific training is required for any operator to become able to use the system.

For the correct use of the device, it is mandatory to carefully read the instructions in *Chapter 8 - Operative information*.



Do not open the device: this could lead to electric shocks or damage to the system. No modification of this equipment is allowed. Do not use the instrument if the cover or other parts of the device have been removed.

Only technicians authorized by the Manufacturer may service the device. The Manufacturer cannot be held responsible for system safety should the device be opened, repairs carried out, third party's software be installed, or parts be replaced by unauthorized persons.



Do not use the device while it is attached to a PC through the USB cable.



Any USB cable and any battery charger used to charge the battery, when not provided by the manufacturer, shall comply EN 60950-1.



The battery of the 2WIN cannot be replaced with equivalent item not provided by Adaptica, for safety reason (risk of explosion).



The operator is not allowed to perform a DOWNGRADE of the 2WIN software. Adaptica is not responsible for the improper use of the device with a downgraded software version.



The device needs to be operated in a semi-dark room (dim light condition), in order to help pupil dilation.

6 Quick user guide

6.1 Important

- Carefully read *Chapter 5 – Precautions* of the present manual before operating the device.
- The 2WIN is a portable binocular vision analyzer. It measures refraction of both eyes at the same time.
- The 2WIN should not be confused with a table-top auto-refractometer (AR). ARs are designed to measure refractive errors of one eye at time, in an artificial condition of far fixation.
- Working in natural binocular conditions, the 2WIN allows to evaluate simultaneously not only refractive errors, but also gaze direction, ocular alignment, pupil diameter, pupil distance, and the accommodative balance/unbalance between the 2 eyes.
- Please familiarize yourself with the measurement conditions and techniques of the 2WIN in order to exploit its full potential.

6.2 Main Applications

- The 2WIN is a portable binocular vision analyzer. It detects a patient's real-time refraction.
- It is a binocular instrument that measures refraction on the basis of eccentric InfraRed photo-refraction (also photo-retinoscopy). Both eyes are measured at the same time, while fixating at 1 meter.
- It is battery operated, non-invasive, fast, and easy to use.
- It automatically measures binocular refraction, pupil distance, pupil size, direction of gaze, and fixation abnormalities.
- Binocular refraction of infants and children from 6 months of age, seniors, impaired and non-cooperative patients.
- Early detection and documentation of multiple amblyogenic factors.
- Over-refraction of glasses or contact lenses.
- OPTIONAL (APPs):
 - CR-App: phoria/tropia measurements;
 - DP-App: dynamic pupils' response time and size caused by artificial light created by 2WIN;
 - LC-App: centering of the visual axis on the glasses frame;
 - 66cm-App: addition power measurement at 66 cm distance from the patient (for visual display unit, VDU).

6.3 Exam conditions



With reference to electromagnetic compatibility, the device is designed for use in a professional healthcare facility environment.

- The patient shall sit comfortably in a suitable exam room; infants should sit in adult's lap. A uniform dim light environment is necessary.
- The 2WIN accuracy is affected by external sources of light, in particular hot lights' halogen or incandescent lamps because of the presence of high infrared content of the light; make sure no direct light hits the patient's face and ensure uniform light on both eyes.
- A stable measurement distance of 1 meter shall be maintained.

6.4 Measurement tips

- For sphere and cylinder, measurement precision is ± 0.25 D or ± 0.50 D depending on the range. The cylinder axis is calculated between 1° and 180° (step 1°) with precision of $\pm 5^\circ$. For high refractive errors (above +7 D and below -7 D), the 2WIN displays "high M" (myopia) or "high H" (hyperopia) in the upper part of the display. For higher refractive errors (above +15 D and below -15 D), the 2WIN still displays "high M" or "high H": in this case, the 2WIN will not display a numerical result, but it will write "N.A." (Not Accessible measurement). For big refractive errors, in the case 2WIN succeeds to estimate the spherical power only, this estimation will appear in the upper part of the display. This maximum spherical estimation is between ± 15 D. Refer to Section 15.1 for further information.
- Make sure the cylinder notation (minus or plus) is set to your preference.
- During the measurement, make sure that both eyes appear within the Graphical User Interface (GUI); if necessary, slightly tilt the 2WIN.
- To refract infants, children, and non-cooperative patients, you can turn ON the audible and/or visible fixation targets. Audio fixation (attraction system) is preferable to the visible lights fixation.
- Make sure the Reliability Index of the measurement is higher than 6 (max. is 9). In case it's lower than 6 a message with a hint will be displayed, for the repetition of the measurement.
- For accurate over-refraction with glasses, make sure that no light reflexes disturb the pupil detection; should such reflexes be present, please slightly tilt the glasses down.
- Remember that free space, non-cycloplegic refraction can vary depending on several conditions pertaining to the binocular visual function; in some specific patients, including accommodating children, the 2WIN measurements may vary.

7 Description of the device

7.1 2WIN

The measuring principle of 2WIN is based on infrared photorefraction. In this technique, infrared light is projected through the pupils of the patient onto the retina. Depending on the refractive error, the reflected light forms a specific crescent-shaped brightness pattern within the pupil. The spherical refraction is calculated based on this crescent pattern. Cylinder and axis measurements are based on the same kind of calculation, repeated on four meridians.

2WIN performs the measurement 1 meter (3 feet 3 inches) away from the patient (contact-less), with continuous tracking of the corneal reflex, for the analysis of the binocular alignment, and with sensors to check the measurement distance.

2WIN accepts a pupil diameter between 4 and 7 mm and it is compatible with the measure both in mydriasis (dilation of the pupil) and in miosis (constriction of the pupil). It is possible to measure down to 3.5 and up to 11 mm, but this depends on good environmental conditions. Outside the 4-7 mm range the overall precision could decrease.

2WIN, moreover, is able to detect the refraction only of patients which eyes permit good Purkinje images. Anomalies in such images, due for example to eye-surgery interventions or intraocular lenses (IOL), do not allow an accurate measurement.







2WIN incorporates sight and sound stimuli for the use with children and uncooperative patients (note that sound is preferable to the sight stimulus).

2WIN is portable, battery powered, equipped with a computing integrated unit, with a display for verification of the conditions of measurement and for displaying the results. This is controlled via push buttons.

2WIN data can be saved inside the device (inside a MicroSD Flash memory card) and downloaded outside the instrument through USB connection or Wi-Fi. Moreover, data can be sent through email service to the operator's email address once it is saved in the 2WIN, or finally it can be sent to an email-printing-enabled Wi-Fi printer.

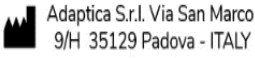
ATTENTION: during any data access to the 2WIN data and, in particular when connecting 2WIN to a computer via USB or Wi-Fi, the SD card of 2WIN must be inside the 2WIN SD card connector.

7.2 Labels

Label	Detail	Explanation
	Adaptica S.r.l. Via San Marco 9/H 35129 Padova - ITALY	Manufacturer identification Data: name and address
Model: 2WIN		Model name
SN :serial number		Serial number
		CE mark and Notified Body identification code
		Electrical / electronic device subject to the WEEE Directive on waste disposal
		UDI code (expressed as GS1 Data Matrix and in human readable format)
FCC ID		Identifies the Wi-Fi/Bluetooth transmitter module

DEPRACATED LABELS – only for backwards compatibility

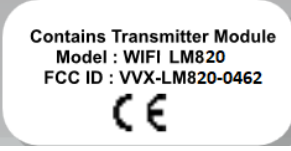
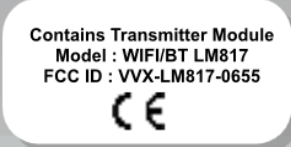
	Model: WiFiHU-a FCC ID IC	Identifies the Wi-Fi transmitter module
	Model: LM820 FCC ID	Identifies the Wi-Fi transmitter module
	Model: LM817 FCC ID	Identifies the Wi-Fi/Bluetooth transmitter module

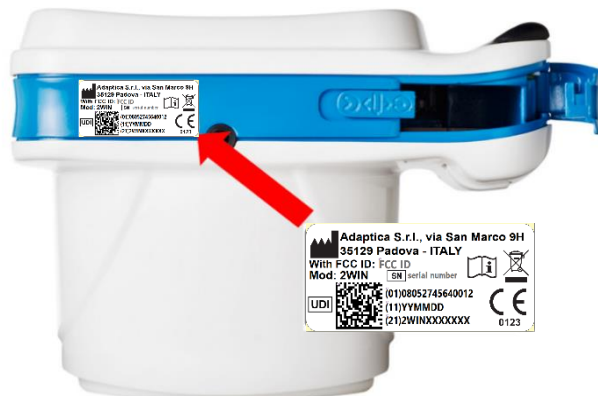

7.3 Package labeling

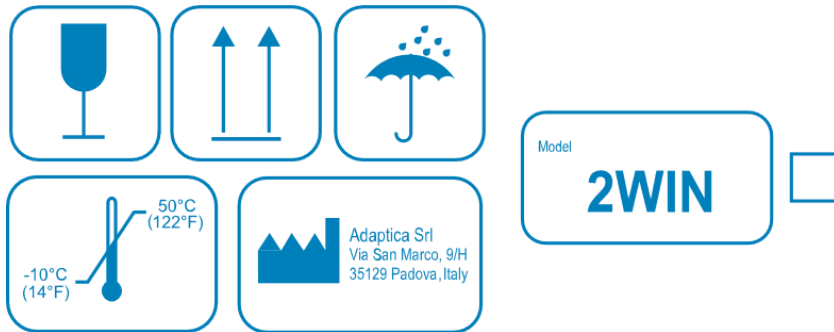

Label	Detail	Explanation
	Adaptica S.r.l. Via San Marco, 9H 35129 Padova - Italy	Manufacturer identification Data: name and address
		Fragile – handle with care
		This side up – do not reverse
		Keep dry
		Storage minimum and maximum temperature
		Lithium ion batteries contained or packed with device Call +39 049 773 968 for more information





7.4 Interfaces



Inside the USB & SD connection door there are a Micro-USB port and a MicroSD card holder.

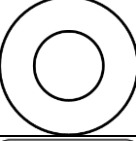

A summary of the functions of the buttons is reported below.

	MAIN FUNCTIONS		Short press	Long press
<i>Patient side</i>	BUTTON S1 & S2			Start focusing phase; releasing, start a measurement
<i>Operator side</i>		BUTTON A	Switch-on; open Applications Menu	Switch-off
		BUTTON B	Zoom after exam	Print and Save
		JOYSTICK	Navigate in the Menu	CENTER: contextual help
		BUTTON C	Toggle eye	Notification center
		BUTTON D	Enable interactivity features	Quick Menu

- ① The buttons have different behaviors within the different submenus: these will be described in the manual in the corresponding paragraphs.
- ① Buttons S1 and S2 share the same function. On one hand, for example, a right-handed user can start a measurement with button S1; on the other hand, a left-handed user can turn the device upside down and use button S2.

Long CENTER push the JOYSTICK to display the “Contextual help”, that explains buttons functionality.

The JOYSTICK features contextual functions:

- Push CENTER to enter Menu or to say OK.
- Short RIGHT push: activates auxiliary window. This window displays the results of main Application (screening) and of additional Applications.
- Long RIGHT push: selection of age interval for standard screening. Push RIGHT to switch between 'Ok' button, 'Cancel' button and the list of age intervals.
- Long UP push: changes positive and negative cylinder representation for the running measurement.

During the examination some keys change their function:

- Push LEFT to toggle ON/OFF the sound.
- Push RIGHT to toggle ON/OFF the light.

After the measurement:

- Push CENTER to enter Menu.
- Push RIGHT to display the auxiliary window.

Active keyboard mode buttons:

- JOYSTICK's CENTER button: select the field (or letter) highlighted.
- JOYSTICK's UP/DOWN/RIGHT/LEFT buttons: move between characters.
- BUTTON A: exit.
- BUTTON B: moves the cursor in different fields.
- BUTTON C: backspace.
- BUTTON D: resume.

7.5 Graphical user interface

The graphical user interface is displayed in these figures:

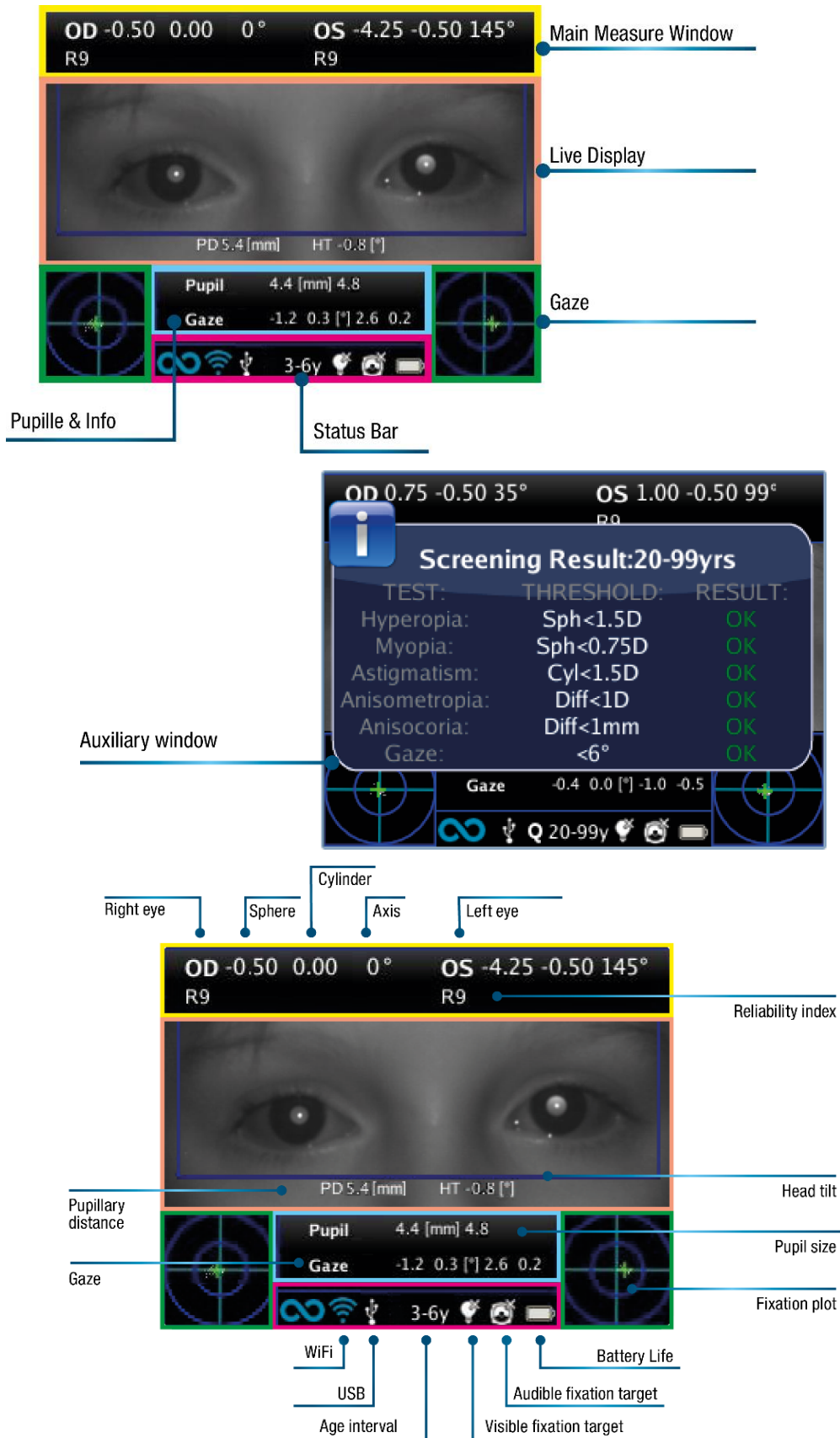

8 Operative information

8.1 Operating conditions

The device needs to be operated under the following environmental conditions:

- Temperature: 10 to 40 °C (50 to 104 °F)
- Humidity (max): 90% not condensing

8.2 Unpacking

The box contains (default configuration):

- the 2WIN device
- two rechargeable batteries
- a MicroSD memory card (containing the electronic version of the Operator Manual) - SD card filesystem must be FAT32
- a USB cable (Micro-USB to USB-A)
- an external battery charger
- an occluder (infrared patient's eye occlusion system)

 The MicroSD memory card, besides containing the electronic version of the manuals, it contains also presentations and further instructions on how to operate the device.

 For further information regarding 2WIN and its Applications, please refer to video tutorials that can be found in the Adaptica's YouTube channel: <https://www.youtube.com/user/AdapticaSrl>.

8.3 Insert battery

To insert the battery, slide the battery lock, hold it and gently open the battery door located in the lower side of the device. Pay attention in inserting the battery with its connector facing down towards the instrument's inside so that the connector of the battery matches the connector inside the device.

Close the battery door and lock it.

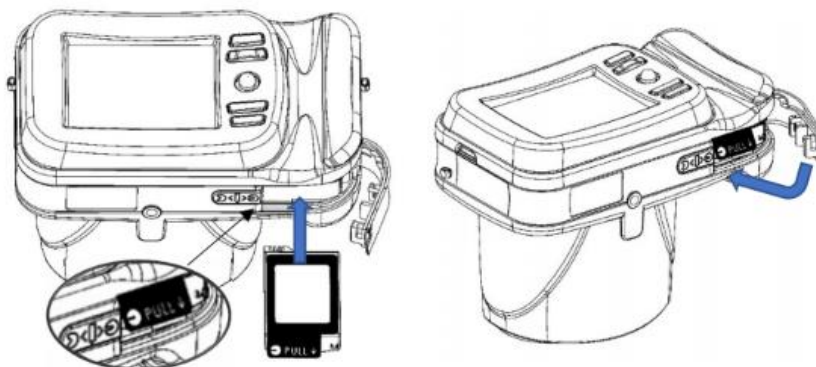

8.4 Extract battery

To extract the battery, slide **completely** the battery lock, hold it firmly and gently open the battery door located in the lower side of the device.

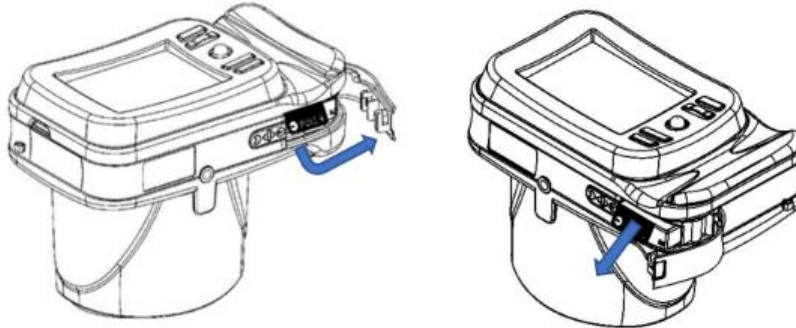

8.5 Battery-charging

- ⓘ Charge the batteries with the external battery charger provided.
- ⓘ On first usage, batteries need to be charged for at least 4 hours.
- ⓘ Batteries must be charged at least once every 30 days.
- ⓘ If used properly, 2WIN batteries have a lifecycle of 400 cycles of complete charge/discharge.



The recharge via USB port connected to a computer is not allowed.



Do not use 2WIN batteries more than 3 years old. Do not use swollen or damaged batteries.



The device will not be able to perform any exam while connected via Micro-USB port.



To reduce the risk of injury, charge only battery model CS-SP112XL and PSP-110ML.



Use the battery charger only with accessories supplied by Adaptica (e.g., USB cable, power supply, etc.).

LVSUN CPS110 battery charger



To correctly use the external CPS110 battery charger, align the battery's contacts with the ones on the charger. When the battery is fully charged, the light of the charger turns from red to green.

To guarantee the correct battery charging, keep the battery charger horizontal with respect to the ground during the entire charging process.

C-HE18 battery charger

After inserting the USB type-C cable into the C-HE18 charger, connect the cable to the power supply. Finally, insert the battery into the charger as described in the label (A).

In the following, the description of the LED lights status.

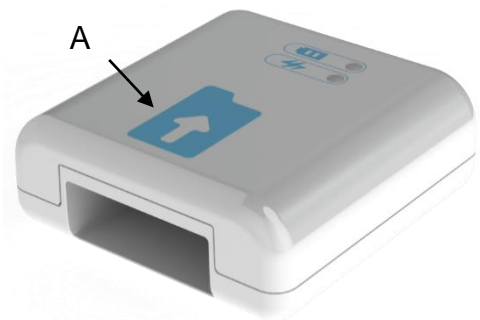

	Red battery light: battery is charging
	Green battery light: battery is charged
	Battery light off: no battery or damaged battery
	Green power light: power on
	Power light off: no power

The C-HE18 battery charger is not available in all countries.

8.6 Before operation

After charging the battery, be sure to set up the date and time. Current date and time will be also used into the measurement results' report. As soon as the battery is assembled and charged, and date/time have been set, the device is ready for operation.

The device has an automatic hardware self-test procedure that can be activated as an option from **Menu > Functions > Aux > Auto test**. This procedure may be executed any time to verify hardware integrity.

8.7 Data management disclaimer

When turned on the first time, 2WIN presents a disclaimer related to the management of data telemetry of the instrument. The operator is asked to read the document and accept the terms, if not 2WIN will work but some functionalities will be disabled (Telemetry and Remote access). You can read the document at the end of this manual (Appendix A) for all the details.

8.8 Software language

2WIN Software is available in English, French, German, Italian, Spanish, and Portuguese (BRA).

The default language is English.

Follow these instructions to load a different language pack in your 2WIN:

1. Download the translation file of interest on your PC from the following link: <https://www.adaptica.com/products/2win/> from the section **Technical Information > SOFTWARE TRANSLATIONS**
2. Connect 2WIN to your PC through the Micro-USB cable, or read the 2WIN's MicroSD card with the PC
3. Create a new folder named 'TR' in the root directory of the MicroSD card
4. Copy the translation file in the 'TR' directory
5. Safely remove the MicroSD device from your PC or disconnect your 2WIN from the PC
6. Reboot your 2WIN
7. At the next start 2WIN Software will be loaded with the selected language pack

Follow these instructions to return to the default English translation:

1. Connect 2WIN to your PC through the Micro-USB cable, or read the 2WIN's MicroSD card with the PC
2. Create a new text file named "*resetTranslation.xxx.txt*" in the 'TR' folder
3. Safely remove the MicroSD device from your PC or disconnect your 2WIN from the PC
4. Reboot your 2WIN
5. At the next start 2WIN Software will be loaded with the default English translation

9 Operative instructions

To power on the 2WIN, push BUTTON A.

To turn OFF the device, long press BUTTON A and then, when the question "Are you sure you want to quit?" appears, push the JOYSTICK to answer OK.

While the instrument is on, the monitor reduces the brightness after 30 seconds of inactivity. Then the monitor switches off after 30 more seconds. After 600 seconds, the device's screen turns on, emits a sound alert, and shows a warning saying that after 30 seconds it will automatically shut down:



Default Auto shutdown Time is 10 min, and it's changeable from a minimum of 10 to a maximum of 180 minutes, in steps of 5 min. It can be customized from **Menu > Settings > Aux > Autoshutdown time**.

To operate the instrument, it's important to carry out the following four steps:

1. **Environment setup**
2. **Device setup**
3. **Preparation of the patient**
4. **Measurement**

9.1 Environment setup

The ambient light should be dim, there should be no direct light pointed towards the instrument or reflected by the eyes of the patient. In case of bad light conditions during the measurement, a message may appear indicating the specific condition.

The device can be used to evaluate the ambient light, from **Menu > Functions > Light Meter**.

After clicking on the JOYSTICK to answer OK, press S1 or S2 button to start the evaluation:

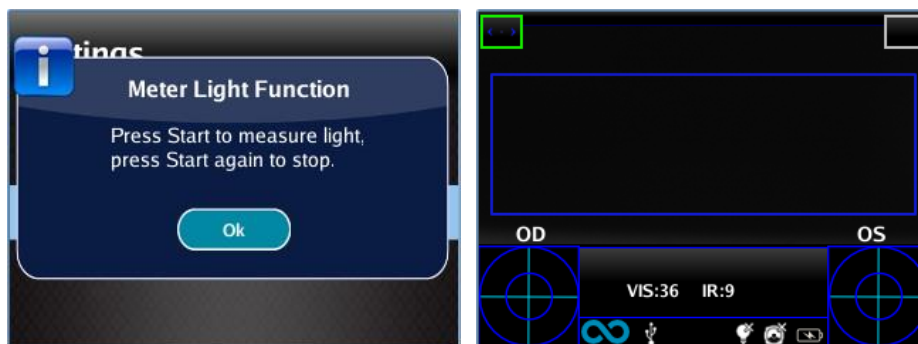

Wait for the "age circle highlight" to disappear and read the VIS and IR values. VIS and IR represent respectively visible light evaluation (0 to 65535 range) and infrared light evaluation (0 to 255 range)

Press S1 or S2 button to stop the evaluation.

- ① Good light conditions are equivalent to a value of VIS between 30 and 80, and of IR less than 30.

9.2 Device setup

As soon as powered ON, the device will perform a fast auto-test, then it will turn directly to exam mode, and the display will show the screen depicted below:



As the device features different exam modalities, an instrument setup must be performed before starting an examination or a sequence of examinations.

Eye selection

There are three options related to which eye of the patient is being measured. By pushing the Eye Selection Button (BUTTON C) the user can toggle between three types of measurements:

- LEFT EYE: only left eye is measured; the blue rectangle covers only the corresponding area (right side of the display).
- RIGHT EYE: only right eye is measured; the blue rectangle covers only the corresponding area (left side of the display).
- BOTH EYES: both eyes are measured; the blue rectangle covers the entire display.

The choice is shown by the presence of the signs OS, OD, or both on the appropriate side of the display.

There is an inversion of left and right due to the fact that the patient and the machine are one in front to the other. Therefore, the sign OS will appear on the right half of the screen, and vice versa.

During a monocular examination, the contralateral eye can be covered or not, at choice of the operator.



Example of single-eye screen

Interactivity features

Interactivity features are built to attract the patient's attention and they are activated through BUTTON D. They can be of three types:

- SOUND: at the beginning of each measurement the system starts a Jingle. The Jingle and the volume can be chosen by the operator in the Menu.
- COLOR LED: at the beginning of each measurement the system starts a flash sequence of red, green, and blue lights. The sequence, the color, and the intensity can be set in the Menu.
- SOUND + COLOR LED: both of the above.

The type of operative interactivity is indicated on the bottom bar through the following symbols:

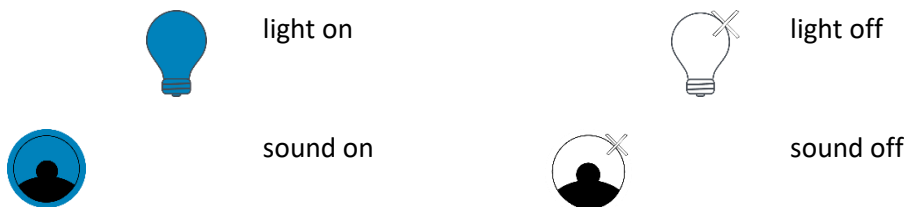

Patient age

2WIN uses the patient's age as a corrective parameter to determine the refraction. This information is used in particular to compensate accommodation in young patients with hyperopia-based refraction error. Take care of selecting the age (long press the JOYSTICK's RIGHT button) before taking the measurement. The age can be modified also after the measurement is acquired, but it is mandatory to select it before saving the exam. Take into consideration that the default age range is 15-50 years.



For safety reasons, to be compliant with the GDPR, from 2WIN software version 5.4.2, the possibility to enter the patient's name is no more available.

9.3 Preparation of the patient

The operator shall instruct the patient to look at the device and open their eyes wide to avoid eyelashes covering the pupils.

In case the patients are not collaborative, the operator should use the interactivity features to attract their attention, by activating either visible flickering lights, sound, or both. We recommend activating first the sound, and the lights only in extreme cases when the sound is not enough.

In case of infants, the patient may be held on the parent's legs during the examination.

Also, it is good practice to ask the patient to keep their head horizontal, although the device will evaluate and automatically compensate for inclination, when measuring the axis of the refraction.

9.4 Measurement

From the start of the examination, a bar at the top of the display appears to give feedback on the measurement conditions: in particular, the bar turns red or green. When the bar is RED, the distance between 2WIN and patient is wrong. Adjusting the distance to 1m will focus the image and obtain a GREEN top bar.

The main steps to perform a measurement will be described in the following.

Turn the 2WIN ON by pressing the ON/OFF button for 1 sec. and wait until the stand-by screen appears. A beep sound stands for 2WIN turning ON.

Please take care to modify the patient age before saving the 2WIN measurement. The 2WIN results in young patient with hyperopia error can be dependent to the patient's age. To change the patient age “long-press” to the RIGHT button of the JOYSTICK and follow the instructions in the 2WIN display.

Instruct the patient to keep his/her eyes wide open, clear of eyelids or eyelashes, and to fixate the center of the camera. Hold the 2WIN horizontally with both hands, approximately at the same height of the patient’s eyes, at a distance of 1 meter.

Press and hold the START button to enter the focusing phase.

Center the eye/eyes of the patient in the active display within the blue rectangle (measurement area).

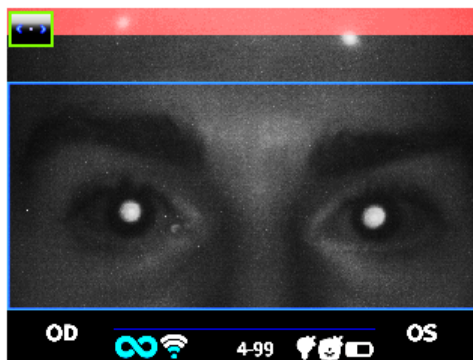

Screen examination – blurred, not in focus. Adjust the distance from the patient

Adjust the distance to focus the image until the top bar is green and the focusing indicator based on corneal reflex shape appears in the center of the screen.

When the top bar is PERMANENTLY green and the focusing indicator (in the center of the image) reaches the highest peak (as shown in the following photo) release the BUTTON S1/S2:

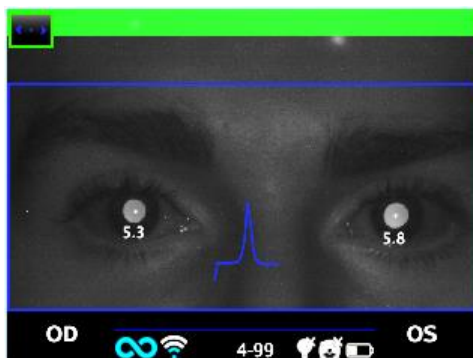

Examination screen – focus OK

Stay firmly in the condition in which the upper bar is green and the focusing indicator is sharp until the message DATA PROCESSING appears on the display (a single-beep sound will confirm this step):



Data Processing message

When the measurement is finished, a two-beep sound indicates that it has been taken correctly (this is a suggested option selectable from **Measurement > Sound > Alerts > Ending Beep**).

If an error occurs during the measurement and a message appears, this last message can be recalled by holding BUTTON C (Notification Center). The error causes can be the following:

- Pupil/s too small or large;
- High IR noise;
- Ambient light too bright;
- Unstable conditions of the data due to other eye problems;
- Other unexpected facts.

If an error message persists after repeating the measurement several times, suggest the patient to have an ocular examination with a licensed doctor.

 For any problems during operation, please refer to *Chapter 14 - Troubleshooting*.

At the end of the measurement the results are displayed:

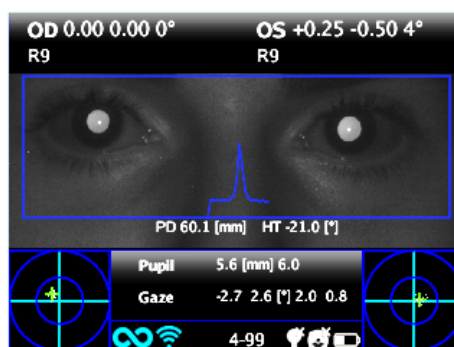

Measurement screen

The top box contains, for OD and OS respectively, the values for sphere, cylinder, axis (TABO system), and the Reliability Index. The latter varies from R1 to R9 (the higher the index, the more reliable the measure). An exam with a low reliability index should be repeated.

The indication “High M” (Myopia) or “High H” (Hypermetropia) can appear below the OD/OS symbol. This label indicates if the eye presents a diopter value higher than 7 D of spherical equivalent.

If “N.A.” is displayed when “High M/H” appears, it indicates that the refraction is outside the range of the 2WIN’s measurement range.

In case of binocular measurement, two values are shown overlapped to the image, inside the blue rectangle. They indicate:

- PD, pupillary distance;
- HT, inclination of the line connecting the centers of the two pupils, referred to the ground.

“Pupil” and “Gaze” represent, for OD and OS respectively, pupil diameters and horizontal and vertical (in this order) offset angles of the average position of the corneal reflex with respect to the center of the detected pupil. Gaze is also graphically depicted for each eye in the two bottom corners of the display, through a cloud of dots and an averaging cross inside two concentric blue circles.

From the results screen the options are:

- Press and hold BUTTON B to save the exam in the SD memory card, or to print the exam’s results.
- Press BUTTON B to zoom on the patient’s eyes.
- Press S1 or S2 buttons to start a new measurement.
- Press BUTTON C or D to change the device’s setup for the next measurement.
- Press JOYSTICK to enter the Menu.
- Press JOYSTICK to the bottom to recall the last valid measurement performed (in case of invalid, uncompleted measurement).
- Press JOYSTICK to the right for the amblyopia screening table.
- Long press JOYSTICK to the right to select the age interval.

Please, refer to the following sections for detailed information of some of the abovementioned options.

9.5 Browsing Mode

The browsing mode allows to recover patient's data previously saved in the 2WIN's SD memory, by holding the JOYSTICK downwards from the home window. Pushing the JOYSTICK up or down allows to switch between different patients; the data (patient number, age, exam date, folder name, software version) is shown for some seconds and then disappears. However, it can be recalled by pushing the JOYSTICK to the left.

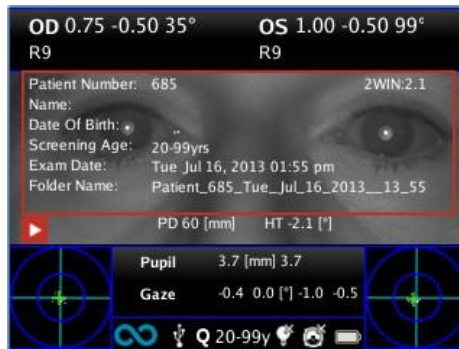

Browsing mode: recall of an old measurement

It is possible to add a filter in the patient number for the search of a specific patient by pressing BUTTON D: an icon shows that the filter is active.

9.6 Zoom function

When the measurement is completed, the operator can zoom on the acquired patient's pupils. To do so, short press the BUTTON B. To go back to the main visualization, short press the BUTTON A.

The Zoom function has two options, on the bottom left of the screen: the Zoom (lens) and the Pan (hand). The option in use is indicated with a lighter square. You can change function by pressing the JOYSTICK or BUTTON D.

Zoom Function

The Zoom frame will automatically be positioned on the left pupil zoomed to the maximum (4x). If it couldn't identify the pupils (failed measurement), it will be positioned on the center of the image.

The Zoom function allows you to increase or decrease the magnifying power on the image, by pushing the JOYSTICK up or down, from a maximum of 4x to a minimum of 1x, with a step of 0.2x.

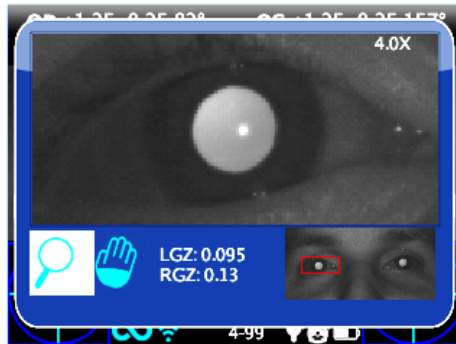

Zoom function screen

To change pupil, press the JOYSTICK to the left or right.

You can center and zoom another image's detail by selecting it with the Pan function and then adjusting the zoom power.

The Zoom function centers automatically the selected pupil, but in case of changing to the Pan function the zoom will leave the pupil center and the system will point to the new position selected by the PAN function. To return to the automatic zooming on the pupil you have to push the JOYSTICK to the right or left.

Pan Function

The Pan function allows you to locate any detail of the image. After selecting it, you must use the JOYSTICK to browse in the image (hold the button for rapid movement). After positioning on the detail, you can change the function to the zoom power you want through the JOYSTICK.



Pan function screen

Auto-research of pupils

In case of automatic identification of the pupils, the function will act as shown above. If it doesn't, the zoom window will automatically get in position on the right pupil and that means it has identified only one of them. If the zoom gets in position on the center of the image it means that no pupil has been identified and you must proceed with the manual positioning.

Manual research of pupils

You can search for the pupils using the Pan function, and save their positions by pressing BUTTON C.

After saving the two pupils positions, you must return to the main screen (pressing BUTTON A) and then save the exam holding BUTTON B.

Once the new position has been saved you just need to reload the new exam from the SD memory to use the Zoom App again.

9.7 Menu

Through the Menu it is possible to configure all the features and the working modes of the device.

The Menu is activated by pressing the center of the JOYSTICK. To exit the Menu, push left on the main Menu page, or short press the BUTTON A.

To navigate the Menu, use the four directions of the JOYSTICK: up and down will move up and down the highlighted choice, right will select the highlighted choice navigating deeper by one level in the Menu, left will step back to the previous Menu level.

 The selected options are highlighted with a blue verification mark on the left of the related setting.

Main Menu page is schematized in the following picture:

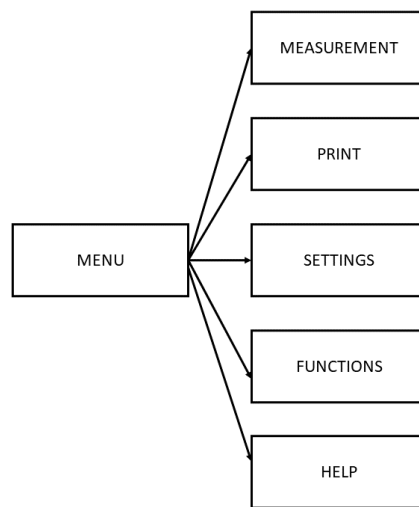

- The submenu **Measurement** collects the settings related to the examination.
 - **Display** allows to change the way results are presented on the display:
 - **Cylinder**: choice between plus and minus cylinder. Once the measure is displayed, it's still possible to toggle between the two visualizations by pushing the JOYSTIK upwards.
 - **Sphe. EQ**: choice between showing the spherical equivalent in the exam results or not.
 - **Sound** configures the interactivity sound:
 - **Volume**: sets audio power output, within a range of four levels.
 - **Jingle**: choice between three available melodies.
 - **Alerts**: allows to activate the ending beep at the end of the measurement.
 - **Fixation** configures the interactivity light:
 - **Rainbow Fixation**: choice between four **Intensity** levels for the visible LEDs in front of 2WIN, and activation of a customer **Sequence**. The latter is configured by placing a custom file in the SD card (as explained in the *Customization* paragraph).
 - **Central Fixation**: allows to activate the visible central fixation light (red).

- **Screening** allows to change the way the screening table is presented on the display:
 - **Show Current Table:** displays the current table, the default or the customized one.
 - **Update User Table:** is selected when uploading a newly compiled user table.
 - **Threshold Settings:** choice between (a) **Screen Displayed:** measurement of what is seen on screen - this is the only mode dependent on how the data is displayed; (b) **Screen Max Axis:** measurement with a notation that maximize the sphere; (c) **Screen Min Axis:** measurement with a notation that minimize the sphere.
 - **Show at end:** automatically displays the auxiliary window of each Application at the end of the exam.
- The submenu **Print** collects the settings related to the printing process.
 - **Device** allows to select the preferred printing method(s):
 - **IR Printing:** enables printing through IrDA to portable printer.
 - **Print on SD memory:** enables saving the exam in the MicroSD card of the device.
 - **BT Printing:** enables printing through a portable Bluetooth printer.
 - **Mail Printing:** enables Mail Printing service (see Section 9.13).
 - **Options** allows to select the way the results are presented when printed:
 - **Grid on Report:** enables the overlay of a grid on the exam report saved in the MicroSD card.
 - **Strip in Pdf:** allows to save a pdf file similar to the IrDA/BT strip.
 - **Print screening on IrDA:** enables printing the full exam through IrDA to a portable printer.
 - **Export Patients** allows to export all the exams stored in the MicroSD card in a CVS file.



Further information on IrDA printing and compatible printers could be found in our website at Products > 2WIN > Manuals Download. Otherwise, feel free to contact support@adaptica.com.

- The submenu **Settings** collects the settings related to the general operation of the device.
 - **Wireless** allows to verify and modify all the wireless connections that the device can have:
 - **Wireless ON:** enables the Wi-Fi connection from the device.
 - **WiFi Status:** shows information about the current Wi-Fi connection.
 - **WiFi Config:** allows to search and select a Wi-Fi network to connect to.
 - **WiFi Options:** allows to set a **2WIN Password** for the device, or to auto connect to known networks (**Auto Connect WiFi**).
 - **Connections:** activates the connection from the 2WIN to the Adaptica's Cloud (**Cloud Pair**), to the VisionFit application (**VisionFit Connection**) or to the tablet WiFi application (**App Connection**).



Note that the Menu item “Cloud Pair” is a feature only present for compatibility with future development.

- **Bluetooth** allows to verify and modify all the Bluetooth connections that the device can have:
 - **Bluetooth ON:** enables the Bluetooth connection from the device.
 - **Bluetooth Status:** shows information about the current Bluetooth connection.
 - **Bluetooth Config:** allows to search and select a Bluetooth device to connect with.
- **Kaleidos** allows to activate the proper configuration when the 2WIN is used inside the Kaleidos (2WIN-S configuration).
- **Date/Time** allows to modify the date and time settings:
 - **Date/Time Format:** allows to choose between H12 or H24 format.
 - **Set Date/Time:** allows to set current date and time.
- **Aux** allows to modify operational parameters of the device:
 - **Autoshutdown Time:** allows to change the auto shutdown timing (in minutes).
 - **Backlight:** allows to change the LCD display backlight intensity, between four options.
- The submenu **Functions** collects four further features.
 - **2WIN Applications** allows to set some options for the available Applications. Refer to the dedicated manual *2WIN Applications Manual*.
 - **Aux** allows to select and run device verification tests:
 - **Auto Test:** starts a hardware self-test of the device.
 - **White Fielding:** enables, on next exam, a device verification test. Refer to *Chapter 15 – Maintenance and Cleaning Instructions*.
 - **Light Meter** enables an evaluation of the ambient light.
 - **Raw Data Acquisition** allows the save of every single image taken from the 2WIN in the MicroSD.



Note that the Menu item “Raw Data Acquisition” is an advanced feature available ONLY for Service purposes, helped by specialized technicians.

- The submenu **Help** collects informative features for the user.
 - **Show Help** shows information about the correct use of the device.
 - **About** shows information about the device, such as the software and hardware version, to be communicated to your distributor when sending a support request.
 - **Remote Control** enables Adaptica Srl to connect to the device in case of malfunctioning.

9.8 Spherical Equivalent

From 2WIN's software version 5.5.0, the Spherical Equivalent can be displayed with the exam results.

You can do so by enabling the option in **Menu > Measurement > Display > Sphe. EQ.**

The Spherical Equivalent value will be displayed both in measurement mode and in browsing mode.

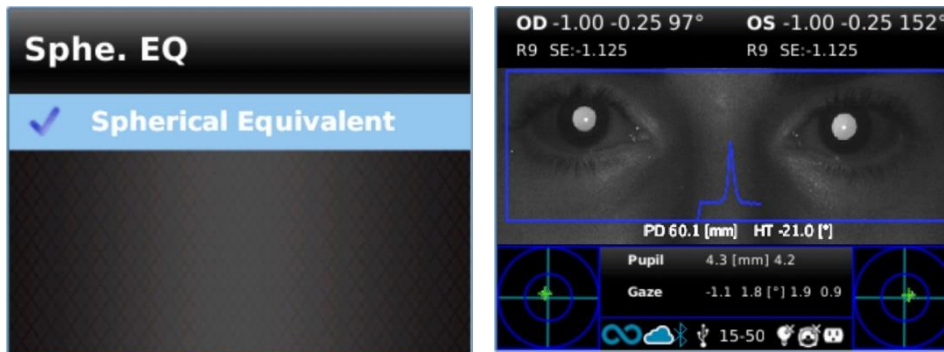

9.9 Quick Menu

To recall rapidly the most used functions of the 2WIN, the operator can activate the Quick Menu by keeping pressed BUTTON D. The Quick Menu items appear at the top right; the '+' button allows to add new items. Items can be erased and moved by keeping pressed the JOYSTICK to the left.

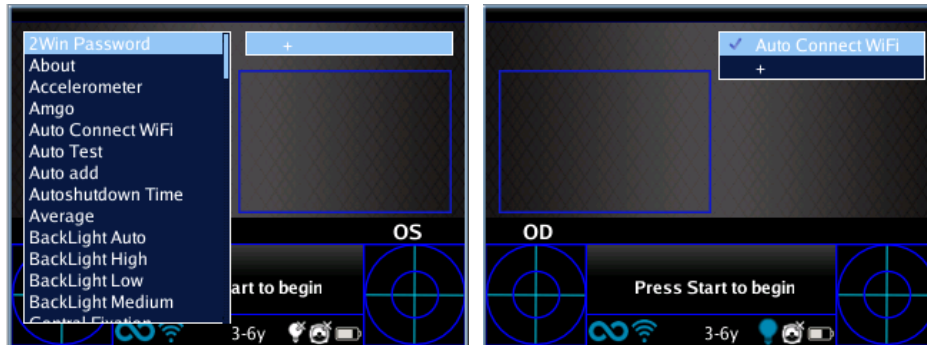

9.10 Contextual Help

At any time, long pressing the JOYSTICK, a help page is shown if the page provides one. Pages with the help option are: Home, Menu, Keyboard, Age Selection, Browsing Mode, Date and Time.

An example of the contextual help is shown below; note that the two light blue circles at the top bottom of the window represent buttons S1 and S2.

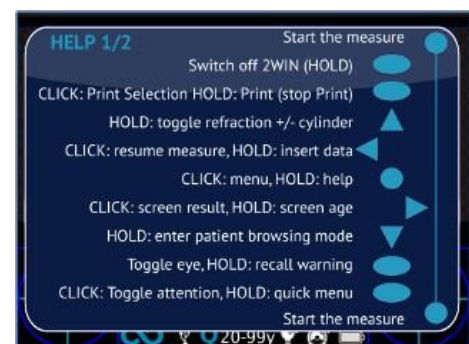

9.11 Save exam

If the SD card is inserted, a set of 4 files for each examination are saved in it, into the folder "2WIN Exams". A subfolder named "Exam #number date" is created, where *date* is the current date and *number* is a sequential number.

The subfolder contains at least 4 files, with the same name of the folder, but different extensions:

- *.pdf = examination results in A4 size paper, other PDF can be written by specific functions.
- *.jpg = original picture of the eyes of the patient.
- *.xml = xml file version of the measurement results.
- *.2win = binary file (for service purposes only).

Below is the description of the PDF report:

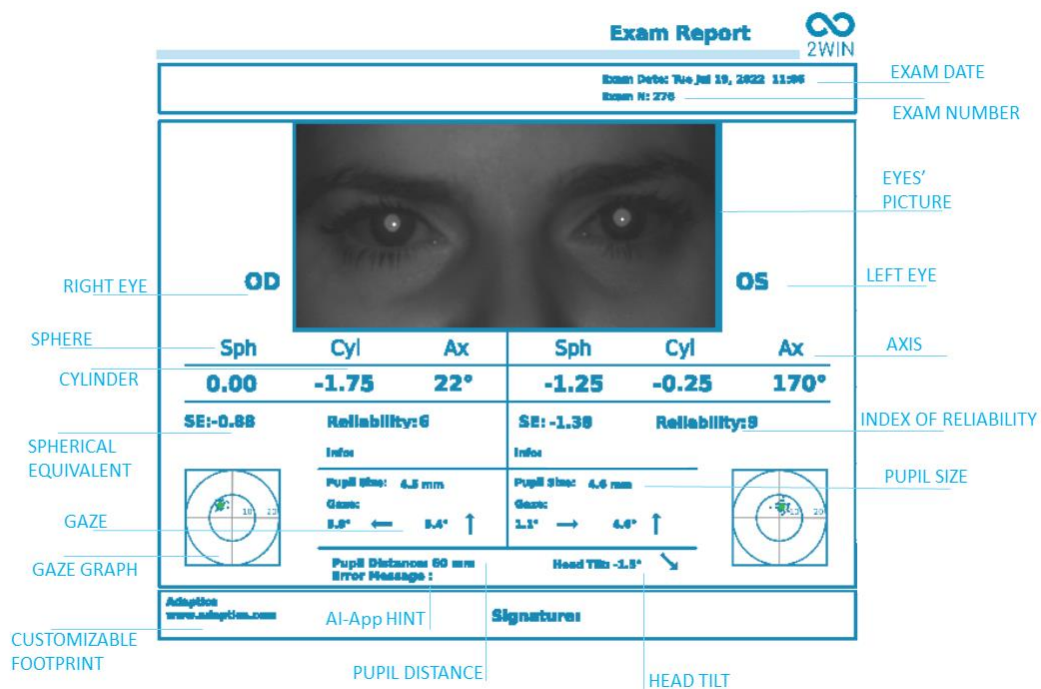

The number of prints before the device starts rewriting the oldest files is 1000.

Data saved in the "2WIN Exams" folder, can be extracted from the MicroSD card by connecting the 2WIN to a PC with the provided USB cable. The 2WIN is seen as an external memory storage.

It is important to safely remove the external memory disk from the PC before disconnecting the USB cable.

Strip in PDF

This option allows the creation of a strip similar to the Autorefractometer strip in PDF format. It can be enabled from **Menu > Print > Options > Strip in Pdf**.

2WIN			
Tue Mar 25, 2014 12:04 pm			
No: 215			
OD:			
SPH	CYL	AX	
-1.00	0.00	0°	6
∅ Pupil: 5.0 mm		Gaze: -4.6 -2.9	
OS:			
SPH	CYL	AX	
-1.00	0.25	115°	6
∅ Pupil: 5.1 mm		Gaze: 3.7 -3.0	
PD: 61 mm			
Adaptica			
www.2winforvision.com			

CSV Exporter Tool

The 2WIN permits to export all the exams stored in the MicroSD card in a CSV file, by selecting **Menu > Print > Export Patient**.

Once activated, the 2WIN creates in the root of the MicroSD memory card the CSV file with the following name format: *Resume_Date_Hour*.

The meaning of the CSV fields is here below described:

SW_VER	software version
N	exam ID
DATE	exam date
TIME	exam time
NAME	patient name
BIRTH	patient birthdate

PD	pupil distance
HT	head tilt
SCR_AGE	screening age
ER_CODE	error code (0 = OK)

LS	left sphere (positive cyl notation)
LA	left cylinder (positive cyl notation)
LAX	left axis (positive cyl notation)
LF	left reliability index
LD	left pupil diameter
LGX	left eye horizontal gaze
LGY	left eye vertical gaze
LHM	left high myopia (boolean)
LHH	left high hyperopia (boolean)

RS	right sphere (positive cyl notation)
RA	right cylinder (positive cyl notation)
RAX	right axis (positive cyl notation)
RF	right reliability index
RD	right pupil diameter
RGX	right eye horizontal gaze
RGY	right eye vertical gaze
RHM	right high myopia (boolean)
RHH	right high hyperopia (boolean)

 2WIN memory is limited: please, consider eliminating old Exams folders and files to free space. Connect the 2WIN to a PC (via USB cable or through an SD card reader), open the "2WIN Exams" folder, make a backup into the PC, and then eliminate all subfolders.

9.12 Print to portable printer

The 2WIN allows to print a strip via portable printer.

IrDA printer

 2WIN allows using IrDA printer. This is a deprecated legacy feature, reported only for backwards compatibility. Further information on IrDA printing and compatible printers could be found in our website at Products > 2WIN > Manuals Download. Otherwise, feel free to contact support@adaptica.com.

Bluetooth printer

From 2WIN's software version 5.6.0, the 2WIN device allows to print a strip via portable Bluetooth (BT) printer.

 **Exam #320**
Type: Binocular
Tue Nov 30, 2021 9:00am
PD: 56mm

Left	Right
SPH : -1.75	SPH : -2.50
CYL : -1.75	CYL : -1.00
AX : 5	AX : 177
Re : 9	Re : 8
PS : 5.4mm	PS : 4.5mm
Gaze: -2.0 -2.0	Gaze: 0.7 0.7

Adaptica s.r.l.
www.adaptica.com

- 1 Enable BT printing, by selecting **Menu > Print > Device > BT Printing**.

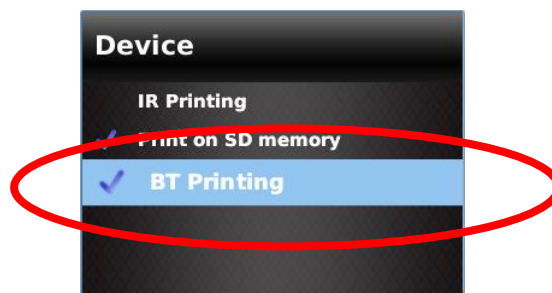

- 2 Pair the 2WIN device with your BT printer. Go to **Menu > Settings > Bluetooth > Bluetooth Config**, select your own printer and press the JOYSTICK's center button.



Be sure that the right BT icon appears in the bottom of the main 2WIN screen.

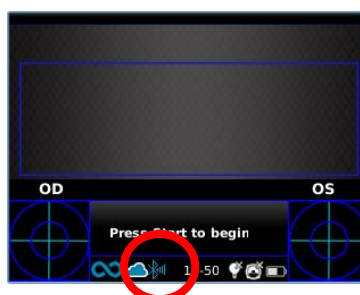

3 In order to print the results strip, long press BUTTON B once the measurement is finished. You can print the same exam as many times as needed.

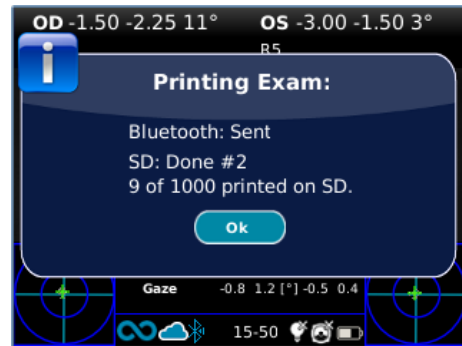
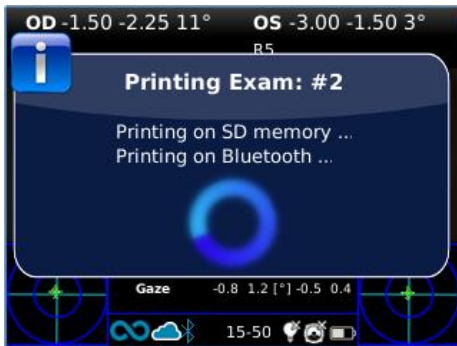

Compatibility

2WIN is compatible with these specific battery-operated printers:

- Zebra ZQ320 and Zebra ZQ320 Plus.

Printer set-up

Make sure that the BT printer's settings are correctly selected in order to work with the 2WIN.

In particular, check in the printer settings that the Bluetooth connection is activated, and that the device is discoverable. Moreover, the device language must be selected as "ZPL".

For example, for Zebra ZQ320:

- download on a mobile phone or tablet the dedicated application (Zebra Printer Setup Utility);
- connect the BT printer with the application;
- on printer's **Connectivity settings > Bluetooth** toggle the "Bluetooth" and "Discoverable" options, being sure to save these options: the BT printer will have to be rebooted;
- on printer's **Device Language > Set Device Language** select "XML and ZPL";
- reboot the BT printer and connect it with 2WIN.



For purchase information, please contact sales@adaptica.com.



If a configured printer will not automatically connect to the 2WIN, please consider switching off and on again the Bluetooth connection from the 2WIN (refer to section 10.1), whilst the printer is active.

9.13 Mail Printing

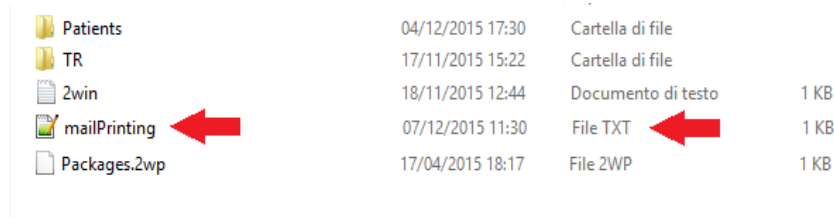

It is possible to send via email the 2WIN's exam results in PDF format. To activate this service, create a text file (*.txt file) named "**mailPrinting.txt**" in the SD root **containing the email you want the files to be sent to** (ex. abc@de.com).



Patients	04/12/2015 17:30	Cartella di file	
TR	17/11/2015 15:22	Cartella di file	
2win	18/11/2015 12:44	Documento di testo	1 KB
mailPrinting	07/12/2015 11:30	File TXT	1 KB
Packages.2wp	17/04/2015 18:17	File 2WP	1 KB

Reboot the device and a new Menu item will appear under **Menu > Print > Device > Mail Printing**.

If checked, after long-pressing BUTTON B at the end of a measurement, an email will be sent automatically to the specified address with the exam's PDF reports in attachment. If the email is related to a Wi-Fi-enabled A4 printer, the PDF report will be sent and directly printed. The email service used is AWS.

-  Remember to be connected to a Wi-Fi network to use the Mail Printing service. If not, the emails will not be delivered. In the same way, the printer must be connected to the same Wi-Fi network.
-  If you modify the email address, remember to reboot the device to apply the modification.

9.14 Gaze

The maps on the two bottom corners of 2WIN's display indicate the eye position (Gaze). This is calculated based on the corneal reflex position but compensated because the light is not centered, and the direction of the eye movement is opposite compared to the movement of the reflex.

The Gaze shows the displacement of the visual axis with respect to the pupil center. This displacement can be related to strabismus, but it normally corresponds to the *K* angle. For a better understanding, it must be confirmed with the CR Application, which allows to identify the Gaze independently from the *K* angle.

The Gaze direction is measured as the distance between the corneal reflex and the geometric center of the pupil. The direction of gaze as measured by this tool is not directly related to the measurement in cover test.

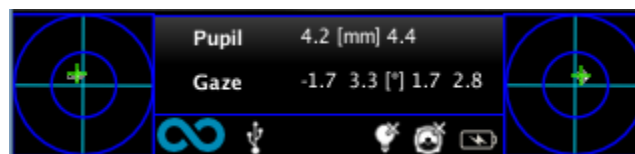

-  The corneal reflex is represented on the graph in an inverted position: if the corneal reflex is nasal to the center, it is represented as temporal in the 2WIN's diagram.

This graphical representation can suggest the presence of tropias and stability/instability of fixation.

9.15 Customization

Some features of the device can be customized by the user. To do so, the user can remove the MicroSD from the device, write on it through a PC, then reinsert it in the device. Otherwise, the user can connect the 2WIN device to a PC via the provided USB cable.

When extracting and inserting the MicroSD card, the device shall be turned OFF.

Custom printouts

To customize the last three lines of the PDF reports (both to portable printer and to file), the user shall create a file named "***printoutPersonalData.txt***" in the root folder of the MicroSD card containing three lines of text of choice.

Example:

Winning Eye Clinic
5, Trafalgar Sq. London
www.winningeye.com



The text file must be saved in UTF-8 codification from your text editor.

Custom RGB sequence

The interactivity light stimulus can be personalized by creating, in the root folder of the MicroSD card, a file named "***rgbCustomSequence.txt***" and enabling custom sequences in the Menu.

The file shall contain 30 or less rows (each containing 4 numbers) coded as follows:

- first number must be in the range 0-5 and codes the mode:
 - 0 = off
 - 1 = rotating rgb
 - 2 = fixed white
 - 3 = rotating black on blue
 - 4 = fixed green
 - 5 = flashing red
- second number must be in the range 50-1000: for modes 1 and 3 it represents the delay
- third number must be in the range 0-255, and it represents the intensity
- fourth number must be in the range 1-30, and it represents the duration

<i>For example:</i>	<i>Will perform:</i>
1 100 10 2	2 seconds rotating with a 100ms delay and intensity 10
0 0 0 1	1 second OFF
4 0 15 1	1 second fixed green with intensity 15
3 500 20 2	2 seconds black rotating on blue with a 500ms delay and intensity 20
3 200 10 2	2 seconds black rotating on blue with a 200ms delay and intensity 10

9.16 Notification Center

This feature gives real-time monitoring of 2WIN’s messaging and logs. Three types of information are reported: notifications on the measurements, notifications on the Wi-Fi networking status and logins, and notifications on the additional software Applications installed.

When there’s a new notification, the 2WIN’s logo is shown with a red background.

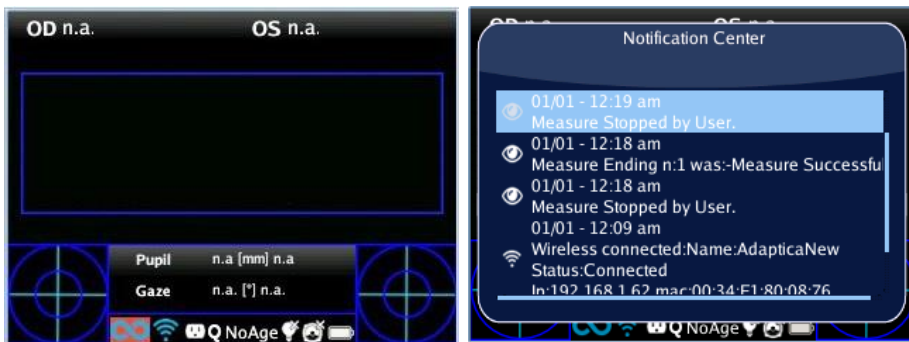

The notifications are stored in the Notification Center in a recursive way; the last 20 are always shown.

To open the Notification Center, press and hold BUTTON C. To exit, press BUTTON A.

9.17 Age Selection

To perform the measurement correctly, you need to select the correct age range for each patient. From the home display, keep pressed the JOYSTICK to the right to display the “Screening Age”.

Take care to modify the patient age before saving the 2WIN measurement, as results in young patients with hyperopia can be dependent on their age.

The current value selected is saved and it’s visualized in the status bar at the bottom of the display.

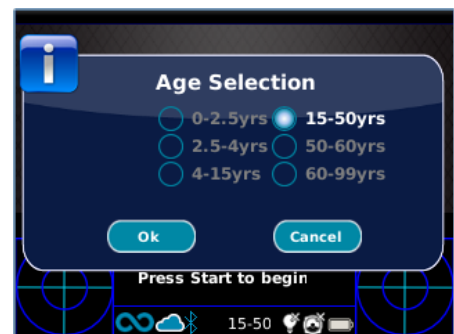

9.18 Screening Table

	HYP:	MYO:	AST:	ANM:	ANC:	GAZ:
0-2.5yrs:	4.5	3.5	2	2.5	1	4.6
2.5-4yrs:	4	3	2	2	1	4.6
4-15yrs:	4	3	2	2	1	4.6
15-50yrs:	3.5	1.5	1.5	1.5	1	4.6
50-60yrs:	3.5	1.5	1.5	1.5	1	4.6
60-99yrs:	3.5	1.5	1.5	1.5	1	4.6

The Screening Table is a set of thresholds that are used by the 2WIN to determine if a patient is inside or outside the guidelines (AAPOS) for amblyopia detection screening.

Visualization

To display the Screening Table, select 'Show Current Table' from **Menu > Measurement > Screening**; the current table, either default or custom (defined by the user), is displayed.

Customization

To insert a custom table, to follow regional or different rules than the AAPOS ones, a text file named *“screeningTable.txt”* has to be created in the MicroSD card of the 2WIN.

Data must be written only in the first six lines of the file, as each line corresponds to an age interval. The **age intervals** are fixed, while it's possible to modify the **thresholds values**.

The columns correspond to the following entries: **Minimum age, Maximum age, Hyperopia, Myopia, Astigmatism, Anisometropia, Anisocoria, Gaze**.

The following as an example:

```

0 2.5 4.5 3.5 2 2.5 1 4.6
2.5 4 4 3 2 2 1 4.6
4 15 4 3 2 2 1 4.6
15 50 3.5 1.5 1.5 1.5 1 4.6
50 60 3.5 1.5 1.5 1.5 1 4.6
60 99 3.5 1.5 1.5 1.5 1 4.6
    
```

A screening is considered passed if the values are compliant to the following thresholds:

- **Hyperopia:** the measured spherical value on all meridians must be lower than the current threshold.
- **Myopia:** the measured spherical value on all meridians must be lower than the current threshold.
- **Astigmatism:** the measure of the absolute value of the cylinder must be lower than the current threshold.
- **Anisometropia:** the difference between the absolute value of myopia or astigmatism between the two eyes must be lower than the current threshold.
- **Anisocoria:** the difference between the two pupil diameters must be lower than the current threshold.
- **Gaze:** if a single eye is measured, the mean gaze position must be lower than the current threshold. If both eyes are measured, the distance between the two horizontal and vertical Purkinje reflections, normalized to the center, must be lower than the current threshold.

Update

From **Menu > Measurement > Screening**, select '**Update User Table**'; a message indicates which table is uploaded (default or user) and if the table has been correctly loaded.

Screening Measurement Result

To display the Screening Measurement result, from the Home Screen push the JOYSTICK to the right.

10 Wireless Connections

10.1 Bluetooth connectivity

2WIN devices equipped with the Bluetooth module, allow:

- the transmission of 2WIN's refraction results to the VisionFit SC; only from 2WIN's software version 5.4 and greater (refer to Section 10.3 for the pairing instructions);
- Printing with portable printer.

The Bluetooth connectivity can be enabled from **Menu > Settings > Bluetooth**. The Bluetooth icon is shown on 2WIN's display:

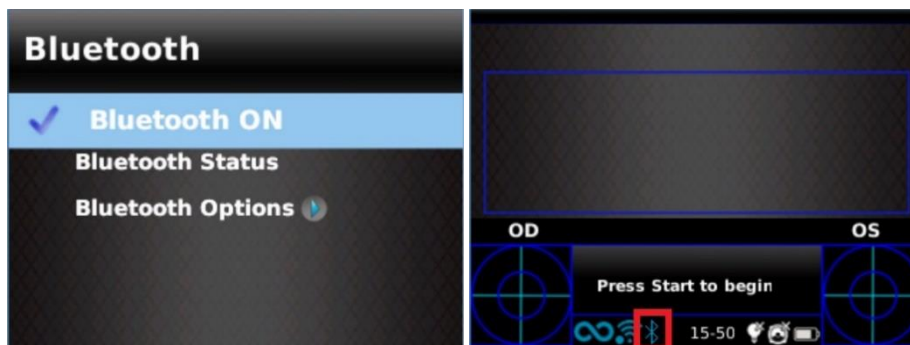

 Bluetooth connectivity is enabled by default on the device.

10.2 Wi-Fi connectivity

A 2WIN equipped with the Wi-Fi module can be connected to a Wi-Fi network, for the following tasks:

- a) transmit the 2WIN's refraction results to the VisionFit SC; devices have to be connected to the same Wi-Fi (refer to Section 10.3 for the pairing instructions);
- b) remote control of the 2WIN through the *2WIN App-Connection Wi-Fi* (VNC + SSH), running on Android tablets: this is an unsupported legacy feature, reported only for backwards compatibility;
- c) remote control for Remote Service and Support;
- d) download the latest software update.

The Wi-Fi connectivity can be enabled in the 2WIN as follows:

1. Click on “**Wireless ON**” from **Menu > Settings > Wireless**. A tick will be displayed next to it.



2. Select the option “**WiFi Config**” and choose your favorite network. When clicking on the JOYSTICK, the password insertion window will appear. Insert the **Password**, then click on the option “**Done**”. Select and click on the option “**Connect**” to connect to the selected network.

You can also enable “**Autoconnect**” in **Menu > Settings > Wireless > WiFi Options**. This option allows to reconnect to the network automatically in case the connection is lost or the 2WIN is turned off.

3. Click on “**WiFi Status**” to (1) **check if the 2WIN is connected to your network** and to (2) **determine the IP address of 2WIN**.



The default password of 2WIN for the VNC + SSH networking service is “**adaptica**”. **This password is a security key for the system. To change it, go to “WiFi Options” and set the new security key.**



For safety reasons, from 2WIN software version 5.4.2, the SFTP service connection is no more available.



It is recommended to change the password as the default one is common to all 2WINs.



Only WiFi 2.4 GHz technology is supported, and only WPA and WPA2 password types can be used. In particular, WiFi type *802.11 a* is not supported, as well as password types like WPA3 or WEP.

10.3 Pairing and transferring a 2WIN exam to VisionFit SC



In the following, it will be described the pairing procedure between 2WIN-S and VisionFit SC. This is a deprecated legacy feature, described only for backwards compatibility.

VisionFit SC is a mobile and wearable subjective refractor which can be used in combination with 2WIN.

Once 2WIN is paired, it's possible to transmit 2WIN's objective refraction results to VisionFit SC, to speed up the subjective refraction measurement.

 On 2WIN's display, the blue sphere on the right side of the Wi-Fi symbol indicates the connection with the VisionFit SC.

Transferring an exam from 2WIN to VisionFit SC using Wi-Fi connection

The first time transferring an exam to VisionFit SC, the pairing needs to be performed as follows:

1. From 2WIN, in **Menu > Settings > Wireless > Connections** enable "**VisionFit Connection**"
2. The following message appears:



3. From VisionFit SC's tablet application, enter **Settings** and set **2WIN Connection type: WIFI**



4. Afterwards, select **2WIN Connection**. The pairing starts automatically.

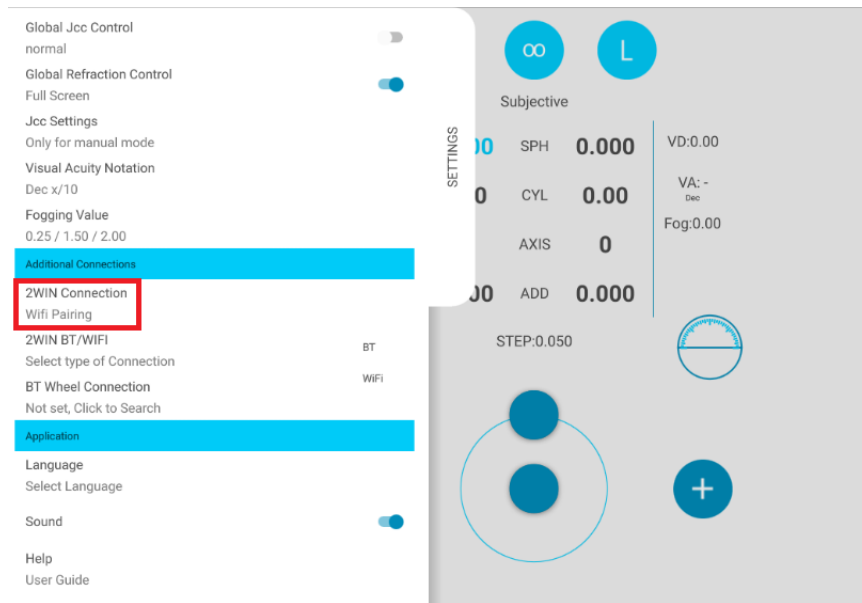

5. When the pairing is complete, a green circle appears on 2WIN's icon.



To transfer 2WIN's measurements to VisionFit SC follow the steps below:

1. Perform a test using 2WIN and save it (or browse for an older exam). Short press the JOYSTICK downwards. 2WIN's data appears instantly on the right side of the VisionFit SC application (Reference area).

2. Press **TO MAIN** button on VisionFit SC's application to add data to the Subjective Area.



Transferring an exam from 2WIN to VisionFit SC using BT connection

The first time transferring an exam to VisionFit SC, the pairing needs to be performed as follows:

1. Enable "Bluetooth" on 2WIN from **Menu > Settings**.
2. From VisionFit SC's tablet application, enter **Settings** and set **2WIN Connection type: BT**

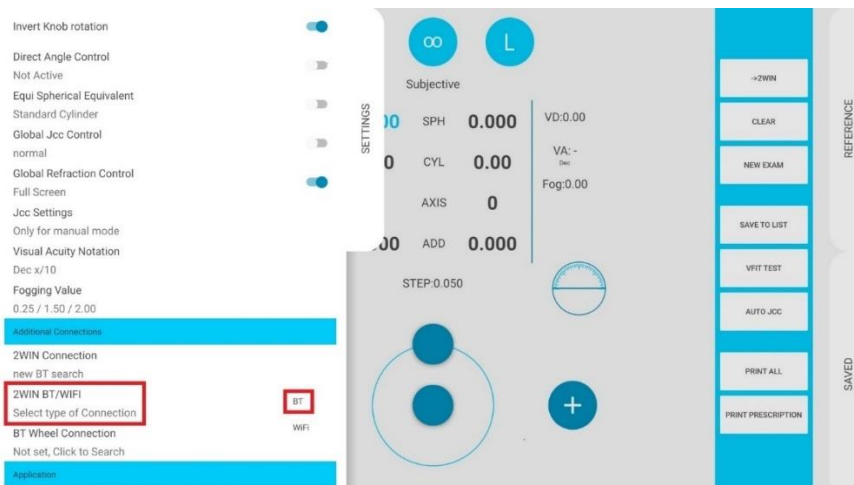

3. Afterwards, select **2WIN Connection**. The pairing starts automatically.

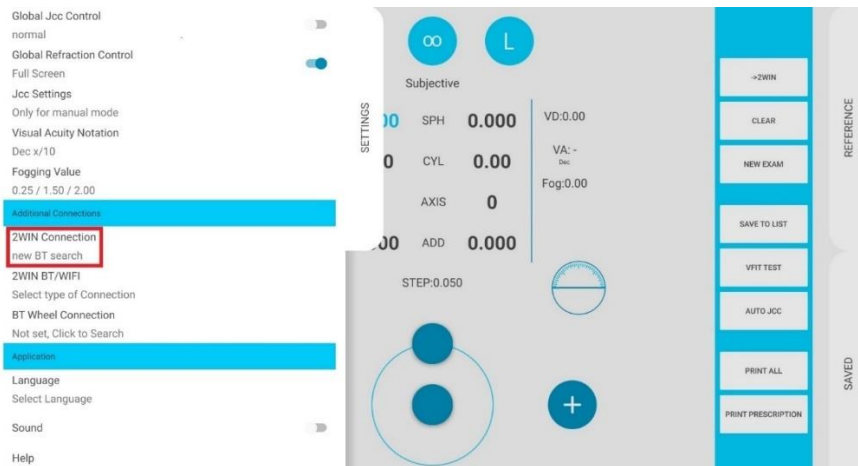

4. Press on 2WIN icon to see a list of available devices: select the desired 2WIN. When the pairing is complete, a green circle appears on 2WIN's icon.



To transfer a 2WIN's measurements to VisionFit SC follow the steps below:

1. Perform a test using 2WIN and save it.

2. Enter the **Reference** area in VisionFit SC's tablet application and tap on the **2WIN+** button.

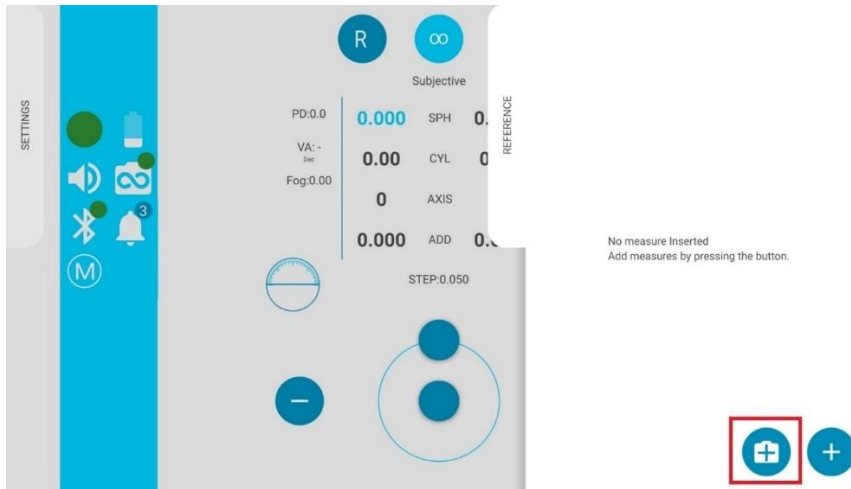

3. 2WIN data will appear instantly on the Reference area in VisionFit SC's application.

4. Press **TO MAIN** button on VisionFit SC's application to add data to the Subjective Area.

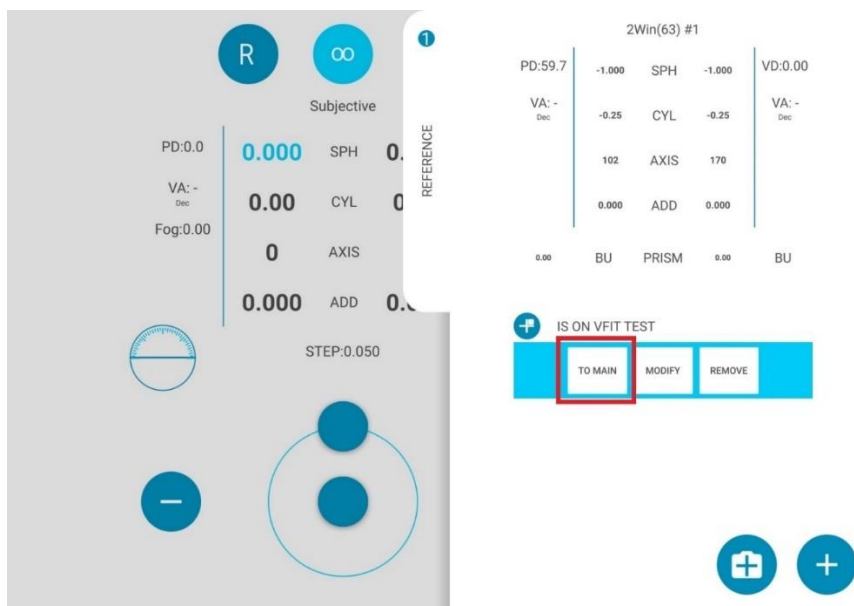

i Pairing does not have a preferred sequence order (VisionFit SC – 2WIN). It can also be performed in reverse order (2WIN – VisionFit SC).

i Pairing is needed only the first time. It must be performed again only if you change devices (2WIN or VisionFit SC).

i Not available measurements from 2WIN cannot be transferred on VisionFit SC.

11 Remote control: 2WIN App-Connection Wi-Fi

 The *2WIN App-Connection Wi-Fi* allows to remotely control the 2WIN, from an Android tablet through Wi-Fi connection. However, it is an unsupported legacy feature, reported only for backwards compatibility. Further information could be found in our website at Products > 2WIN > Manuals Download. Otherwise, feel free to contact support@adaptica.com.

12 Applications

 It is possible to increase the 2WIN's functions with the installation of additional Applications. Each Application is described in a dedicated manual, *2WIN Applications Manual*.

Please, contact support@adaptica.com for further assistance.

13 Software update instructions



After having upgraded the 2WIN software, it is important to reboot at least once the device.

13.1 Manual update procedure

When a software update is released, to install it in the 2WIN, follow the instructions at adaptica.com > Products > 2WIN > Technical information > Downloads > Software Installation Instructions.



The operator is not allowed to perform a DOWNGRADE of the software. Adaptica is not responsible for the improper use of the device with a downgraded software version.



When the software update procedure is performed, the 2WIN's battery must be fully charged.

13.2 Automatic update procedure



To exploit the automatic update, 2WIN must be connected to a Wi-Fi network with Internet connection.

An automatic software update procedure is available for 2WIN. When a new software version is released, and the 2WIN is connected to a Wi-Fi network with internet access, the update is notified on the screen.

At 2WIN's start-up, the system checks if a new update is available. If so, the new software version and release date are reported on the screen and the user can decide to download it or not.

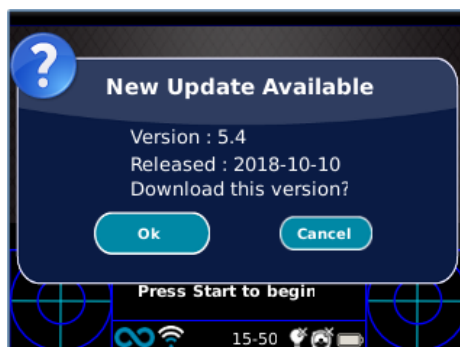

If you decline the update pressing CANCEL, the message will disappear until the next update check; if you want to update your 2WIN press OK and the software download will start.

Before starting the update, make sure that the MicroSD card is inserted, that the device is not connected to any PC with USB cable, and that the battery is fully charged.

- ① The software update's size is about 120MB; with a standard ADSL/VDSL/FIBER connection the download should take just a few seconds/minutes, depending on the connection's speed.
- ① Do not remove the battery or the MicroSD card during this procedure.



After the download, 2WIN will extract the update inside the MicroSD card; this procedure takes less than a minute and the 2WIN will show you a waiting message until the extraction is complete.

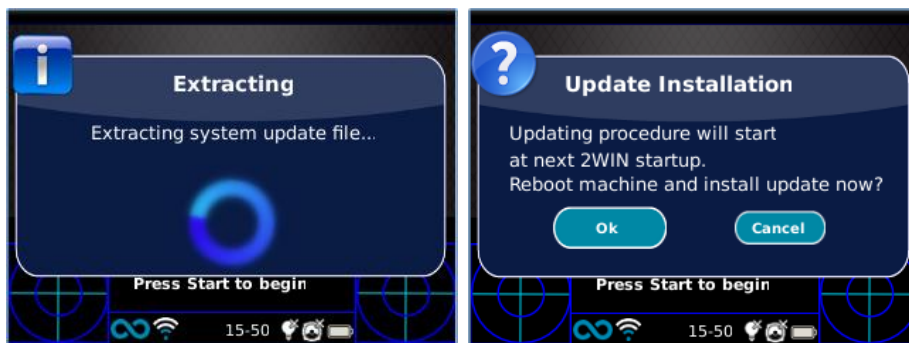

After the extraction, 2WIN will prompt the request of immediate or delayed installation. If the OK button is pressed, 2WIN will restart and run the system update. Press the CANCEL button to delay it (the update will take place at the next 2WIN reboot).

14 Maintenance and cleaning instructions

The device may be periodically verified, by means of a procedure called “white fielding”, as follows:

1. Take a common A4 white sheet of paper and place it at 1 m of distance from the instrument.
2. Turn on the device, enter the **Menu > Functions > Aux**.
3. Select “**White Fielding**” option.
4. Start an acquisition while pointing the system to the white sheet of paper.
5. A message will appear showing the test result.

14.1 How to clean the system

If necessary, it's possible to clean the 2WIN with a lightly moist microfiber cloth. It's recommended to clean 2WIN's lenses at least once a year – more frequently if it's exposed to dust. Use compressed air to clean 2WIN's frontal objective. If necessary, use 70% ethyl alcohol solutions to sanitize 2WIN's plastics. Do not use any other type of solvents or sprays to clean the system.

14.2 Storage instructions

The device needs to be stored under the following environmental conditions:

Temperature: -10 to 50 °C (14 to 120 °F); Humidity (max): 90% not condensing.

14.3 Instructions for the correct disposal of the device

The device is made of different materials, such as plastics, aluminum, electronic parts: in case of disposal, separate the materials and follow the recycling laws and regulations effective in your own country.

14.4 Instructions for the correct disposal of 2WIN's packaging

Part of 2WIN's packaging is made of expanded polyethylene foam, present inside the device's suitcase and between the suitcase and the shipment box. Such foam is eco-friendly and 100% recyclable.

14.5 Separate collection for electrical and electronic equipment

The European Directive 2012/19/EU establishes the separate collection for Waste of Electrical and Electronic Equipment (WEEE). The users of Electric and Electronic Equipment have not to dispose of WEEE as unsorted municipal waste, they have to collect such WEEE separately. The available return and collection system is defined by the local public administration, or in alternative an authorized company can recycle the WEEE. Refer to public administration about the separate collection, if this information is not available, contact the manufacturer of the equipment.

Users have a fundamental role in contributing to reuse, recycling, and recovery of WEEE. The potentially dangerous substances contained in the WEEE can pollute the environment and produce harmful effects to the human health. Please, remember to follow the recycling and disposal laws and regulations effective in your own country.

15 Troubleshooting

#.	Problem	Possible cause	Solution
1	The initial screen does not appear on the display of the device	The battery is completely discharged	Charge the battery
2	On the display, an error message appears	Electronic malfunctioning	Contact the distributor or support@adaptica.com , mentioning serial number and error message
3	On the display an error message appears	Software malfunctioning	Contact the distributor or support@adaptica.com , mentioning serial number and error message
4	A warning – “Hint check Gaze”- appears on the display	The patient is not looking at the device	If collaborative, ask them to look at the device If not collaborative, activate the interactivity features
5	A warning – “Hint check Gaze”- appears on the display	There may be a strabismus problem	It is suggested to measure eyes singularly in two different measurements
6	A warning – “Possible strong Anisocoria” appears on the display	The two eyes have very different pupil diameters	It is suggested to measure eyes singularly in two different measurements
7	The measurement never end correctly or prematurely quit while the pupils are detected	There may be a hardware problem	Run the Self-Test diagnostic through the MENU and contact the distributor or support@adaptica.com
8	The binocular measurement is impossible	Patient underwent eye-surgery or has IOL	It is suggested to measure the eye without issues singularly
9	Portable printer does not work	The printer is powered off/has low battery	Switch on/recharge the printer
10	IR printing does not work	The printer is not in front of the device	Position the printer in line of sight with the device

16 Additional information

16.1 Technical specifications

Measuring range for spherical defect: $\pm 15 D$, step $0.25 D$ in range $\pm 7 D$, step $0.5 D$ outside

Measurement precision for spherical defect in the range $\pm 5 D$: $\pm 0.25 D$

Measurement precision for spherical defect in the range $-15 D$ to $-5 D$, $5 D$ to $15 D$: $\pm 0.5 D$

Measuring range for cylindrical defect: $\pm 5 D$, step $0.25 D$

Measurement precision for cylindrical defect: $\pm 0.25 D$

Measuring range for cylinder axis: 1 to 180 degrees, step 1 degree

Measurement precision for cylinder axis: ± 5 degrees

Measuring range for pupil diameter: 4 to 11 mm, step 0.1 mm

Measurement precision for pupil diameter: ± 0.2 mm

Measuring range for inter-pupillary distance: 30 to 120 mm, step 0.1 mm

Measurement precision for inter-pupillary distance: ± 1 mm

Gaze range: $\pm 20^\circ$; out of range: $\pm 10^\circ$; resolution: 0.1° ; precision: 0.2° (corneal radius of 7.75 mm)

16.2 2WIN Rechargeable battery specifications

Type of Cell: Sealed Lithium-polymer Prismatic

Battery Pack Model: CS-SP112XL or PSP-110ML; replace No.: Sony PSP-S110

Battery Pack Size: 58 X 36.1 X 12.7 (LxWxH mm)

Rated voltage: 3.7V

Rated capacity: 1800 mAh

Standard charge: CC-CV method with charge current of 360mA (model 1) or 600mA (model 2)

Quick charge current: 1800mA

Charger model 1: Lvsun CPSC110; Input: 90-250Vac, 50/60Hz, 100mA; Output: 4.2-8.4Vdc, 800mA

Charger model 2: C-HE18; Input: 5V, 750mA; Output: 4.2V, 650mA

16.3 C-HE18 battery charger information

AC/DC 110/240 VAC, 50/60 Hz

Power cable: USB type-C standard cable; min-max length: 1-1.5 m

Weight: 70 g

Battery charger size: 6.5 X 7.0 X 2.5 mm

Maximum operating temperature: 25°C

The battery charger can be attached to metallic surfaces

16.4 Wi-Fi modules / Bluetooth adapters

Current Model: eyeROBO WB440

Compliance: IEEE 802.11b/g/n/d/e/h/i standards, Bluetooth® v2.1 + EDR, v3.0 and v4.0 (Dual Mode) standards

- Wi-Fi 802.11 b/g/n
- Bluetooth® v4.0 (Backwards compatible with Bluetooth® v2.0, v2.1 and v3.0)
- WPA, WPA-PSK, WPA2, WPA2 -PSK and WEP (64bit & 128bit)
- Encryption schemes
- Full speed Bluetooth® Piconet and Scatternet supported
- USB 2.0 (Full Speed) for data and power source
- Operates in 2.4 GHz Frequency bands

Old Model: LM Technologies LM817

Compliance: IEEE 802.11b/g/n/d/e/h/i standards, Bluetooth® v2.1 + EDR, v3.0 and v4.0 standards

- Wi-Fi 802.11 b/g/n
- Bluetooth® v4.0 (Backwards compatible with Bluetooth® v2.0, v2.1 and v3.0)
- WPA, WPA-PSK, WPA2, WPA2 -PSK and WEP (64bit & 128bit)
- Encryption schemes
- Full speed Bluetooth® Piconet and Scatternet supported
- USB 2.0 (Full Speed) for data and power source
- Operates in 2.4 GHz Frequency bands

16.5 Other specifications

Working distance: 1 m (±5 cm)

Display size: 3.5 inches

Battery charger: AC/DC 110-220 VAC 0.5 A

Weight: 0,84 kg

Dimensions: 165mm x 130mm x 98mm

16.6 Device warranty

The device has normally 18-month warranty, unless otherwise specified.

16.7 2WIN EMC tables

Guidance and manufacturer's declaration – electromagnetic emissions		
The 2WIN is intended for use in the electromagnetic environment specified below. The customer or the user of the 2WIN should assure that it is used in such an environment.		
Emissions test	Compliance	Electromagnetic environment – guidance
RF emissions CISPR 11	Group 2	The 2WIN must emit electromagnetic energy in order to perform its intended function. Nearby electronic equipment may be affected.
RF emissions CISPR 11	Class B	The 2WIN is suitable for use in all establishments other than domestic, and may be used in domestic establishments and those directly connected to the public low-voltage power supply network that supplies buildings used for domestic purposes, provided the following warning is heeded: Warning: This equipment/system is intended for use by healthcare professionals only. This equipment/ system may cause radio interference or may disrupt the operation of nearby equipment. It may be necessary to take mitigation measures, such as re-orienting or relocating the 2WIN Battery Charger or shielding the location.
Harmonic emissions IEC 61000-3-2	Not applicable	
Voltage fluctuations/ flicker emissions IEC 61000-3-3	Not applicable	

Guidance and manufacturer's declaration – electromagnetic immunity				
The 2WIN is intended for use in the electromagnetic environment specified below. The customer or the user of the 2WIN should assure that it is used in such an environment.				
Immunity test	IEC test level	60601	Compliance	Electromagnetic environment – guidance
Electrostatic discharge (ESD) IEC 61000-4-2	±6 kV contact ±8 kV air		Complies	Floors should be wood, concrete or ceramic tile. If floors are covered with synthetic material, the relative humidity should be at least 30 %.
Electrical fast transient/burst IEC 61000-4-4	±2 kV for power supply lines ±1 kV for input/output lines		Complies	Mains power quality should be that of a typical commercial or hospital environment.
Surge IEC 61000-4-5	±1 kV line(s) to line(s) ±2 kV line(s) to earth		Complies	Mains power quality should be that of a typical commercial or hospital environment.
Voltage dips, short interruptions and voltage variations on power supply input lines IEC 61000-4-11	<5 % U_T (>95 % dip in U_T) for 0,5 cycle 40 % U_T (60 % dip in U_T) for 5 cycles 70 % U_T (30 % dip in U_T) for 25 cycles <5 % U_T (>95 % dip in U_T) for 5 s		Complies	Mains power quality should be that of a typical commercial or hospital environment. If the user of the 2WIN Battery Charger requires continued operation during power mains interruptions, it is recommended that the 2WIN Battery Charger be powered from an uninterruptible power supply or a battery
Power frequency (50/60 Hz) magnetic field IEC 61000-4-8	3 A/m		Not applicable	Power frequency magnetic fields should be at levels characteristic of a typical location in a typical commercial or hospital environment.
NOTE U_T is the a.c. mains voltage prior to application of the test level.				

16.8 C-HE18 battery charger EMC tables

Guidance and manufacturer's declaration – electromagnetic emissions		
The 2WIN Battery Charger is intended for use in the electromagnetic environment specified below. The customer or the user of the 2WIN Battery Charger should assure that it is used in such an environment.		
Emissions test	Compliance	Electromagnetic environment – guidance
RF emissions CISPR 11	Group 1	The 2WIN Battery Charger uses RF energy only for its internal function. Therefore, its RF emissions are very low and are not likely to cause any interference in nearby electronic equipment. The 2WIN Battery Charger is suitable for use in all establishments, including domestic establishments and those directly connected to the public low voltage power supply network that supplies buildings used for domestic purposes.
RF emissions CISPR 11	Class B	
Harmonic emissions IEC 61000-3-2	Not applicable	
Voltage fluctuations/ flicker emissions IEC 61000-3-3	Complies	

Guidance and manufacturer's declaration – electromagnetic immunity			
The 2WIN Battery Charger is intended for use in the electromagnetic environment specified below. The customer or the user of the 2WIN Battery Charger should assure that it is used in such an environment.			
Immunity test	IEC 60601 test level	Compliance	Electromagnetic environment – guidance
Electrostatic discharge (ESD) IEC 61000-4-2	±6 kV contact ±8 kV air	Complies	Floors should be wood, concrete or ceramic tile. If floors are covered with synthetic material, the relative humidity should be at least 30 %.
Electrical fast transient/burst IEC 61000-4-4	±2 kV for power supply lines ±1 kV for input/output lines	Complies	Mains power quality should be that of a typical commercial or hospital environment.
Surge IEC 61000-4-5	±1 kV line(s) to line(s) ±2 kV line(s) to earth	Complies	Mains power quality should be that of a typical commercial or hospital environment.
Voltage dips, short interruptions and voltage variations on power supply input lines IEC 61000-4-11	<5 % U_T (>95 % dip in U_T) for 0,5 cycle 40 % U_T (60 % dip in U_T) for 5 cycles 70 % U_T (30 % dip in U_T) for 25 cycles <5 % U_T (>95 % dip in U_T) for 5 s	Complies	Mains power quality should be that of a typical commercial or hospital environment. If the user of the 2WIN Battery Charger requires continued operation during power mains interruptions, it is recommended that the 2WIN Battery Charger be powered from an uninterruptible power supply or a battery
Power frequency (50/60 Hz) magnetic field IEC 61000-4-8	3 A/m	Complies	Power frequency magnetic fields should be at levels characteristic of a typical location in a typical commercial or hospital environment.
NOTE U_T is the a.c. mains voltage prior to application of the test level.			

Information for assistance

For any service requirement, please contact your distributor. Nevertheless, you can contact directly Adaptica at: support@adaptica.com.

Note for service personnel only

Adaptica will make available on request circuit diagrams, components part lists, descriptions, calibration instructions, or other information that will assist service personnel to repair those parts of the equipment that are designated by Adaptica as repairable autonomously.

Remote control

If the service department of Adaptica suggest this option, the customer/operator is asked to activate the “Remote Control” option of the 2WIN. This option can be enabled only in the 2WIN with Wi-Fi connection. Through the use of this option, a direct connection between the 2WIN and the IT department of Adaptica will be enabled in order to give direct support. The operator will be contacted by the IT department of Adaptica by phone, email, or other means, and then the operator must follow the instructions given.



When the “Remote Control” is enabled and used, it’s not possible to access the MicroSD card of 2WIN; the device must be rebooted in order to do that.

Telemetry

The telemetry service is used by Adaptica to get information on the status of the 2WIN (APPENDIX A).

Appendix A – Data management disclaimer

Disclaimer of Adaptica S.r.l. pursuant to Article 13 of Legislative Decree No. 196 of 30 June 2003 (the “Privacy Code”)

We hereby inform that the utilization of the 2WIN instrument will give rise to the processing of some data relating to its status of operation (the “**Telemetry Data**”), which will be acquired by the IT systems and software procedures for the functioning of this instrument whenever it connects to a wireless network. The information in question is not collected in order to be associated with specifically identified parties, but due to its nature it could – through processing operations and associations with data in the possession of third parties – make it possible to identify the users (hereafter the “**Parties Concerned**”). The Telemetry Data include the software version, the firmware version, the device’s serial number and the number of observations carried out; moreover, the instrument will transmit the list of the Applications operating on the same. The sole purposes of the Telemetry Data processing are to enable Adaptica S.r.l. to constantly monitor the efficiency of the proposed service based on the utilization of the 2WIN instrument and, in case of malfunctioning of the same, to transmit from the remote server the technical data which are necessary to the reactivation of the relevant parameters. Furthermore, Adaptica S.r.l. may, once a temporary session of remote control has been activated by the user and the instrument has been connected to a wireless network, connect to the 2WIN instrument and obtain parameters of a purely technical nature relating to the handling and the state of health of mechanical, electronic and firmware parts (the “**Remote Control Data**”). In this regard, Adaptica S.r.l. informs that, by way of the remote control connection, also the data saved on the SD card might theoretically be downloaded from the system, should such card be left inserted in the instrument at the moment of the activation of the temporary session; despite this additional information is of no interest for Adaptica S.r.l. and will neither be acquired nor treated by it, it is however advisable to remove the SD card or delete any sensitive data before such activation, in order to avoid the transfer of the same data.

Adaptica S.r.l. also informs that the Telemetry Data and the Remote-Control Data do not contain sensitive information relating to users, will be treated only and exclusively in the framework of normal business, in accordance with purposes linked to the achievement of the corporate purpose of the said Adaptica S.r.l., and will be kept by such company. The Telemetry Data will be used only in order to acquire anonymous information on the use of the instrument and to check that it is functioning correctly. The Remote-Control Data will be used in order to provide remote assistance to the 2WIN and enable Adaptica S.r.l. to check its functioning and/or carry out particular procedures. The processing of the Telemetry Data and the Remote Control Data will take place mainly through electronic (or in any case automated), IT and telematic instruments, and will be memorized on IT devices, following criteria strictly correlated to the aforementioned purposes, in compliance with the minimum security provisions contemplated by Art. 34 of the Privacy Code and by Schedule B thereof and, in any event, in such a way as to ensure the security and confidentiality of such Telemetry Data and Remote Control Data.

The lack of consent by the Party Concerned to the processing of the Telemetry Data and the Remote-Control Data will make the use of the 2WIN instrument impossible to the same. The autonomous owner (“*titolare autonomo*”) of the Telemetry Data and the Remote-Control Data is Adaptica S.r.l., a company with its registered office in Padua, Via San Marco 9/H.

The Telemetry Data and the Remote Control Data may be conveyed to the Italian Personal Data Protection Authority as well as any other governmental and regulatory authorities so entitled, in accordance with the Applicable legal and/or regulatory provisions; to advisors and professionals; to service companies; and to any other entities to which such notices have to be conveyed for the purposes of providing the services, and in such a way as to comply precisely and diligently with contractual requirements and obligations imposed by current legislation. In any case, the Telemetry Data and the Remote-Control Data will not be disclosed. The complete and updated list of the persons/entities to whom the Telemetry Data and the Remote-Control Data may be conveyed and of those who may acquire knowledge thereof as data supervisors ("*responsabili del trattamento*") (the "**Supervisors**"), together with this disclosure, will be made available at the registered office of Adaptica S.r.l.

Finally, Adaptica S.r.l. informs that the law grants all the Parties Concerned the specific rights that are set out in Article 7 of the Privacy Code; purely by way of example and without limitation, these include the right to ask for, and obtain, confirmation of whether or not Telemetry Data of one's own exist and to ascertain their origin; the purposes and modalities of the processing; and the updating, rectification and, where required, integration of the said Telemetry Data. The Parties Concerned may also, within the limits imposed by the law, ask for any inexact or incomplete data to be corrected, updated or integrated and, for Telemetry Data processed in breach of the law, to be cancelled or blocked, or oppose their utilization for justified reasons which must be indicated in the request (pursuant to Art. 7 of the Privacy Code).

I hereby declare that I have read the privacy disclaimer set out above and specifically authorize the processing of the Telemetry Data and the Remote-Control Data for the purposes described therein and in order to facilitate compliance with contractual and legal requirements, pursuant to Legislative Decree No. 196 of 30 June 2003, the "Personal Data Protection Code".

Place and Date _____

Signature of the declarant (legible and written in full) _____